





US Navy

Non sibi sed patriae.



6	5+	4+
4	12	36



Torpedo and Bomb Values			
	2		6
		7	3
		AP	AP*
			GP

Special Rules

American Planes

The **Dauntless** and **Helldiver** divebombers carried much heavier ordnance than their predecessors the Vindicators, or their counterparts in other fleets. Their AP bomb value is "7" rather than the normal "3." (These bombs are designated "AP*" above.)

The **Corsair** costs four points each.

Pickle Barrels

American torpedoes are *Poor Quality* through the end of 1943. They add +1 to the difficulty of a shot. In 1944, American torpedoes have a value of "3" and are no longer *Poor Quality*.











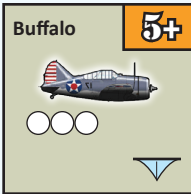

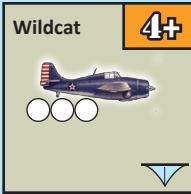
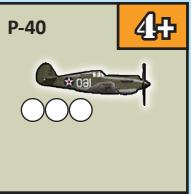

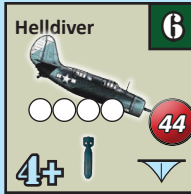

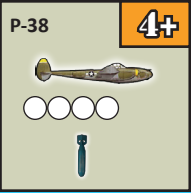







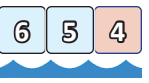
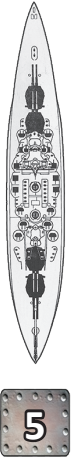
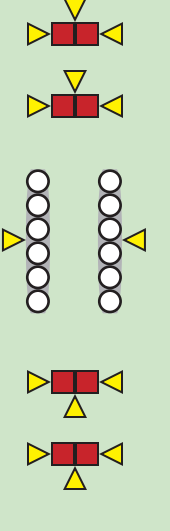

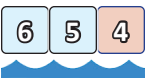
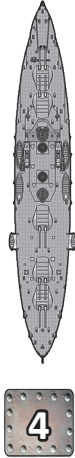
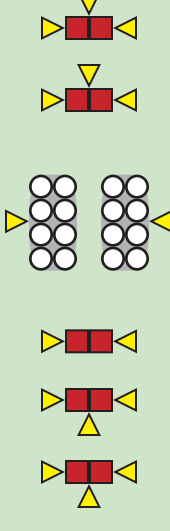

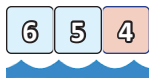
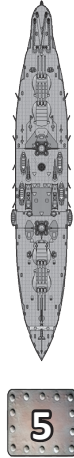
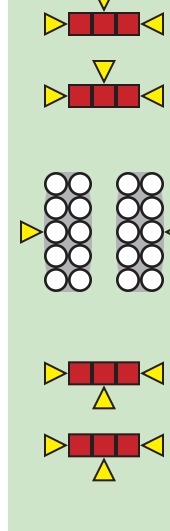



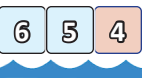

Allies

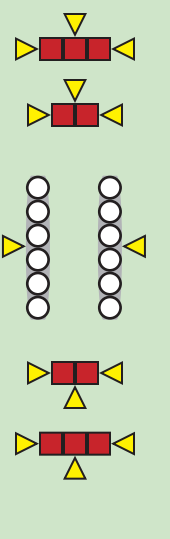
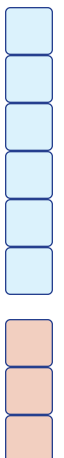

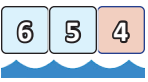
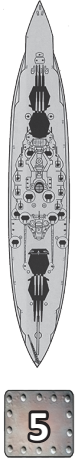
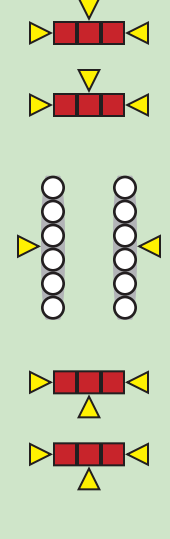

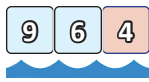

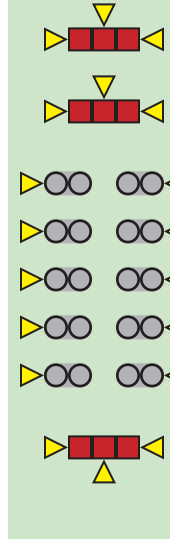

You may purchase Dutch or Australian ships. They have the same repair level as American ships.







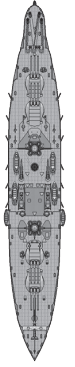
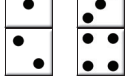
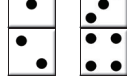
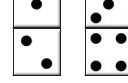

American Planes





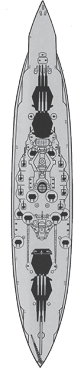

1 Point Each	 <p>Buffalo 5+</p>	 <p>Vindicator 6</p>	 <p>Devastator 6</p>		
2 Points Each	 <p>Wildcat 4+</p>	 <p>P-40 4+</p>	 <p>Avenger 6</p>	 <p>Dauntless 6</p>	 <p>Helldiver 6</p>
3 Points Each	 <p>Mitchell 5+</p>	 <p>P-38 4+</p>	 <p>Hellcat 3+</p>	 <p>B-17 5+</p>	 <p>Corsair 3+</p>

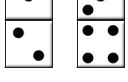
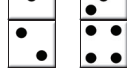
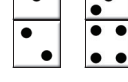



	BB	30	
Colorado class (3)			
		6 5 4	
0 1	1 0		
0 1 4	5 6 9	2 3 4	7 8 9
• •	• • •	• • • •	5
			
New York class (2)			
		6 5 4	
0 1	1 0		
0 1 4	4 5 8	2 3 4	6 7 8
• •	• • •	• • • •	4
			
Pennsylvania class (2)			
		6 5 4	
0 1	1 0		
0 1 4	4 5 8	2 3 4	6 7 8
• •	• • •	• • • •	5
			

	BB	30	
Nevada class (2)			
		6 5 4	
0 1	1 0		
0 1 4	4 5 8	2 3 4	6 7 8
• •	• • •	• • • •	5
			
New Mexico or Tennessee class (5)			
		6 5 4	
0 1	1 0		
0 1 4	4 5 8	2 3 4	6 7 8
• •	• • •	• • • •	5
			
North Carolina or South Dakota class (6)			
		9 6 4	
-1 2	0 1		
0 1 4	5 6 9	2 3 4	7 8 9
• •	• • •	• • • •	6
			

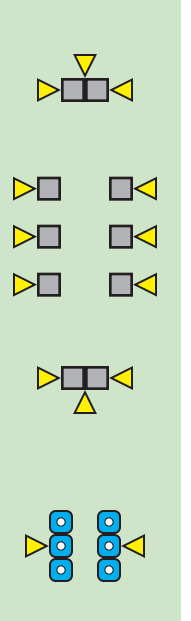
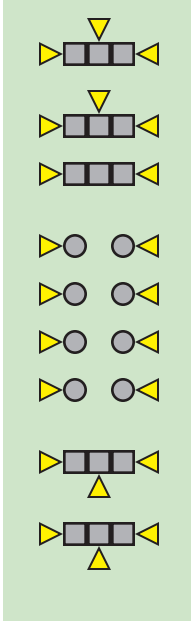
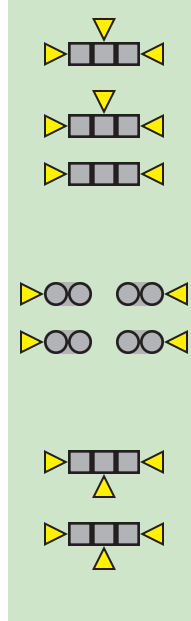
	BB	48	44		BB	35	44		BB	35	44
Iowa class (4)				Colorado class (3)				Pennsylvania class (1)			
	12	9	6		6	5	4		6	5	4
-1	3			-1	2			-1	2		
0	2			0	1			0	1		
											
0	1	4		0	1	4		0	1	4	
5	6	9		5	6	9		4	5	8	
2	3	4		2	3	4		2	3	4	
7	8	9		7	8	9		6	7	8	
											
6				5				5			

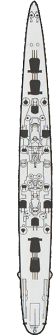

	BB	35	44		BB	30	44		BB	26	44
Nevada class (1)				New Mexico or Tennessee class (5)				Alaska class (2)			
	6	5	4		6	5	4		12	9	6
-1	2			0	2			-1	2		
0	1			1	1			0	1		
											
0	1	4		0	1	4		0	1	4	
4	5	8		4	5	8		3	4	7	
2	3	4		2	3	4		2	3	4	
6	7	8		6	7	8		5	6	7	
											
5				5				4			

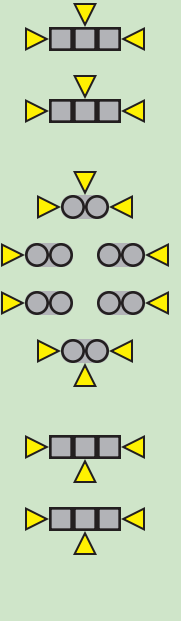
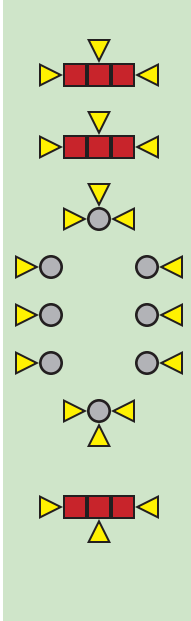
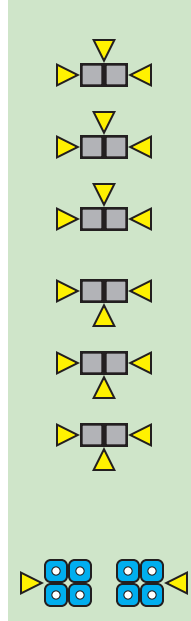
 CR 5	Omaha class (10)	 CR 11	Brooklyn class (9)	 CR 11	St. Louis class (2)
					
					

 CR 11	Cleveland class (27)	 CR 20	Wichita Wichita class (1)	 CR 9	Oakland class (6)
					
					

 **CR 20**

New Orleans or Portland class (16)

  12 9 6
 0 1
 1 0



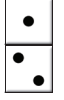
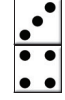
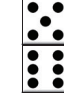

0 1 4
 2 3 6
 2 3 4
 4 5 6



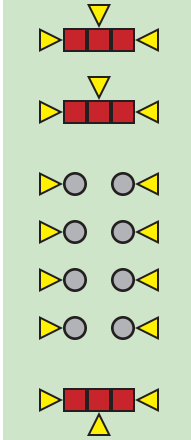

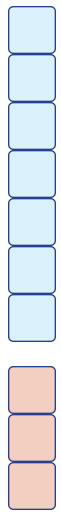



 **CR 17**

Northampton class (6)

  12 9 6
 0 1
 1 0

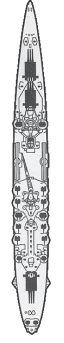

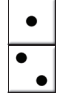
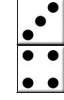
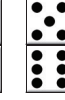

0 1 4
 2 3 6
 2 3 4
 4 5 6



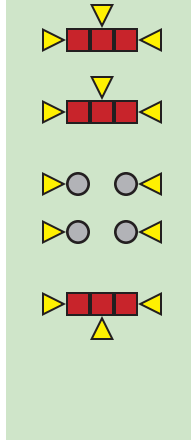







 **CR 17**

Pensacola class (2)

  12 9 6
 0 1
 1 0



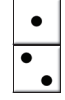
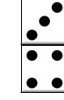

0 1 4
 2 3 6
 2 3 4
 4 5 6



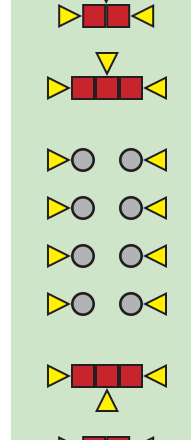







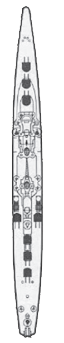

 **CR 9**

Atlanta class (4)

  12 9 6
 -1 2
 0 1





0 1 4
 2 3 4



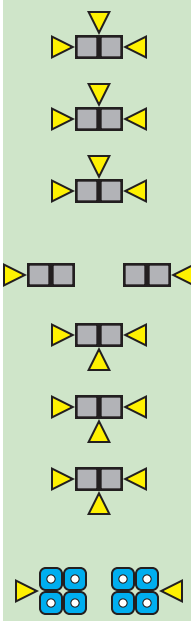

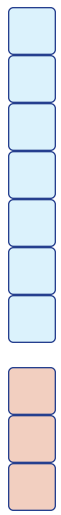







 **CR 23**

Baltimore class (14)

  12 9 6
 -1 2
 0 1



0 1 4
 2 3 6
 2 3 4
 4 5 6

  



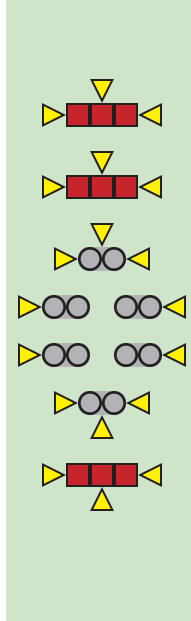

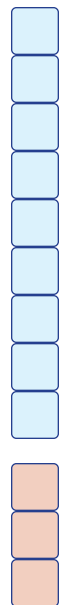



44

 DD 3

Farragut class (8)

 

0 1
1 0

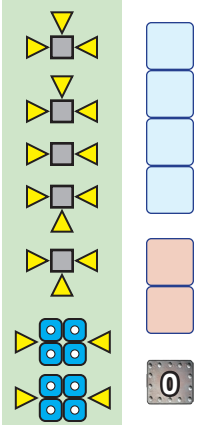

0 1 4
2 3 4

0



 DD 4

Porter class (8)

 

0 1
1 0

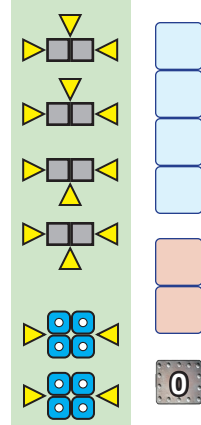

0 1 4
2 3 4

0



 DD 4

Mahan, Sims classes (30)

 

0 1
1 0

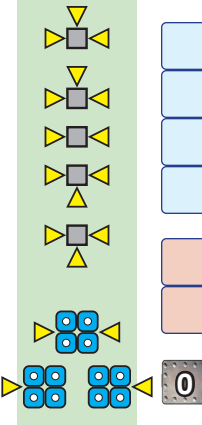

0 1 4
2 3 4

0



 DD 2

Clemson class (+)

 

0 0
1 0

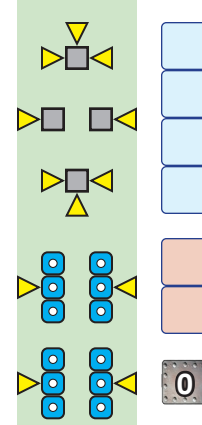

0 0 3
1 2 3

0



 DD 4

Bagley & Benham classes (18)

 

0 1
1 0

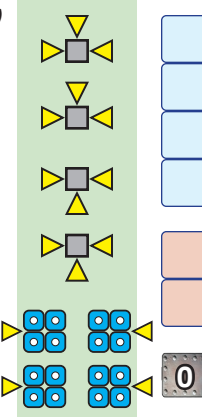

0 1 4
2 3 4

0



 DD 4

Fletcher, Gleaves, Benson classes (+)

0 1
1 0

0 1 4
2 3 4

0

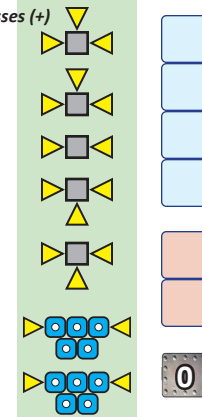

CV 40

Lexington class (2)

12 9 6 3 12 6

1 0

READY AIRCRAFT

UNREADY AIRCRAFT

CV 35

Yorktown class (3)

12 9 6 2 12 6

1 0

READY AIRCRAFT

UNREADY AIRCRAFT

CV 30 Wasp

Wasp class (1)

12 9 6 1 12 6

1 0

READY AIRCRAFT

UNREADY AIRCRAFT

CV 25 Ranger

Ranger class (1)

12 9 6 1 8 4

1 0

READY AIRCRAFT

UNREADY AIRCRAFT

CV 40 44

Essex class (14)

12 9 6 3 12 6

2 1

READY AIRCRAFT

UNREADY AIRCRAFT

CV 20 44



Independence class (9)

12 9 6 2 6 3

1 0

READY AIRCRAFT

UNREADY AIRCRAFT

	CV	10	44		CV	15	44
Casablanca, Sangamon, or Bogue classes (+)				Commencement Bay class (14)			
 <input type="text" value="0"/> <input type="text" value="0"/>	<input type="text" value="6"/> <input type="text" value="5"/> <input type="text" value="4"/>	<input type="text" value="0"/>	 4 2	 <input type="text" value="0"/> <input type="text" value="0"/>	<input type="text" value="6"/> <input type="text" value="5"/> <input type="text" value="4"/>	<input type="text" value="0"/>	 6 3
<p style="text-align: center;">READY AIRCRAFT</p>				<p style="text-align: center;">READY AIRCRAFT</p>			
<p style="text-align: center;">UNREADY AIRCRAFT</p> 				<p style="text-align: center;">UNREADY AIRCRAFT</p> 			

M Small Cargo Ship

6 4

0 0



0

M Large Cargo Ship

6 4

0 0



0

M Transport

6 4

0 0



0

M Troopship

6 4

1 0



0

M Auxiliary Ship

9 6

0 0



0

Airstrip

0

10 5

CT

READY AIRCRAFT

UNREADY AIRCRAFT

35

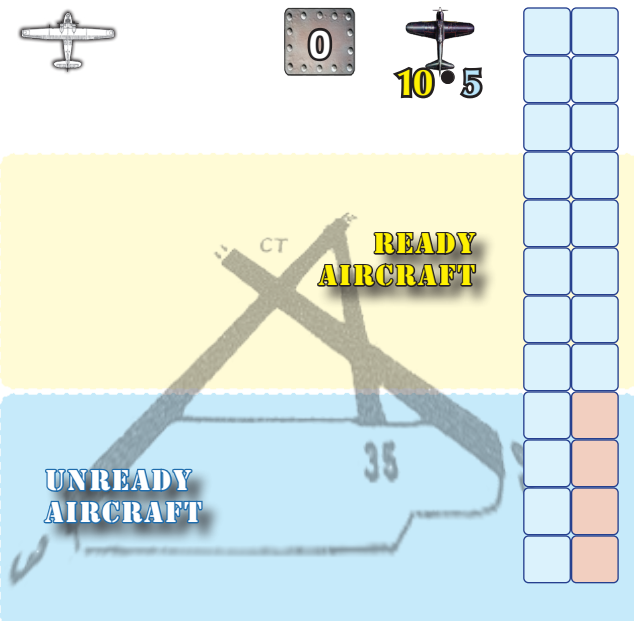

Airfield

0

16 8

CT

READY AIRCRAFT

UNREADY AIRCRAFT

35

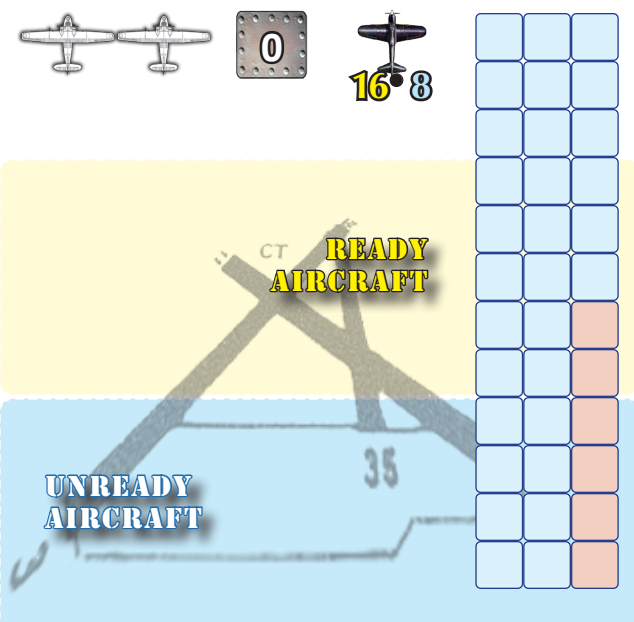

Allied Ships Available to the US Navy

Australia

Australia uses British ships, as follows:

- Two British *County* class cruisers (*Australia* and *Canberra*)
- Three British *Leander* class cruisers (*Perth*, *Hobart*, *Sydney*)
- And any number of British destroyers from any classes.

Netherlands

The Dutch Navy List comprises the ships shown below.

Use British torpedo values for the Dutch.

CR	6	De Ruyter
De Ruyter class (1) 		

CR	6	Java
Java class (2) 		

DD	2	Admiralen
Admiralen class (8) 		

DD	5	Tromp
Tromp class (1) 		