



Marine Nationale

Honneur, Patrie, Valeur, Discipline.



6	5+	4+
2	6	20













Torpedo and Bomb Values			
	4		6
		AP	3
			GP

Created by Igor Petrenko for Sam Mustafa Publishing LLC.

Copyright 2023 by Sam Mustafa Publishing LLC. Permission is granted to reproduce this document for purposes of game play.

New Format:

Unlike the other Navy Lists, this list includes a separate DC for each ship, rather than only one for each class. There are also notes on carrier airgroups within the list.

French Planes	<p>1 Point Each</p> <div style="display: flex; justify-content: space-between;"> <div style="width: 22%;"> <p>Dewoitine 5+</p>  <p>2 circles, 1 inverted triangle</p> </div> <div style="width: 22%;"> <p>Levasseur 6</p>  <p>2 circles, 1 inverted triangle, 5+</p> </div> <div style="width: 22%;"> <p>Vindicator 6</p>  <p>3 circles, 1 inverted triangle, 5+, 1 sword icon</p> </div> <div style="width: 22%;"> <p>Blenheim 6</p>  <p>4 circles, 1 inverted triangle, 1 cross icon, 5+, 1 sword icon, 3 max</p> </div> </div>	
	<p>2 Point Each</p> <div style="display: flex; justify-content: space-between;"> <div style="width: 18%;"> <p>Morane-Saulnier 4+</p>  <p>2 circles</p> </div> <div style="width: 18%;"> <p>Dewoitine 4+</p>  <p>3 circles, 1 inverted triangle</p> </div> <div style="width: 18%;"> <p>Potez 5+</p>  <p>3 circles, 1 sword icon</p> </div> <div style="width: 18%;"> <p>Bréguet 6</p>  <p>4 circles, 1 inverted triangle, 5+, 1 sword icon</p> </div> <div style="width: 18%;"> <p>Lioré et Olivier 6</p>  <p>2 sword icons</p> </div> </div>	
	<p>3 Point Each</p> <div style="display: flex; justify-content: space-between;"> <div style="width: 45%;"> <p>Spitfire 3+</p>  <p>3 circles, 1 cross icon</p> </div> <div style="width: 45%;"> <p>B25/B26 5+</p>  <p>4 circles, 1 inverted triangle, 1 cross icon, 5+, 2 sword icons, 3 max</p> </div> </div>	

BB 26 COURBET

Courbet class, '39-'44

6 5 4

0 0
1 0

Scuttled 09/06/44

0 1 4
3 4 7
2 3 4
5 6 7

4

BB 26 PARIS

Courbet class, '39-'45

6 5 4

0 0
1 0

Sold for BU '55

0 1 4
3 4 7
2 3 4
5 6 7

4

BB 26 BRETAGNE

Bretagne class, '39-'40

6 5 4

0 0
1 0

Sunk 03/07/40

0 1 4
3 4 7
2 3 4
5 6 7

4

BB 26 PROVENCE

Bretagne class, '39-'42

6 5 4

0 0
1 0

Scuttled 27/11/42

0 1 4
3 4 7
2 3 4
5 6 7

4

BB 26 LORRAINE

Bretagne class, '39-'43

6 5 4

0 0
1 0

Broken Up '54

0 1 4
3 4 7
2 3 4
5 6 7

4

BB 26 LORRAINE

Bretagne class, '44-'45

6 5 4

0 1
1 0

Broken Up '54

0 1 4
3 4 7
2 3 4
5 6 7

4

BB 30 DUNKERQUE

Dunkerque class '39-42



12 9 6

0 1
1 0

Scuttled 27/11/42

0 1 4
3 4 7
2 3 4
5 6 7

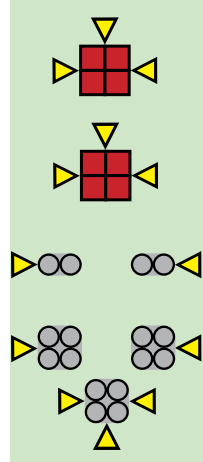
4

BB 32 STRASBOURG

Dunkerque class '39-42



12 9 6

0 1
1 0

Scuttled 27/11/42

0 1 4
3 4 7
2 3 4
5 6 7

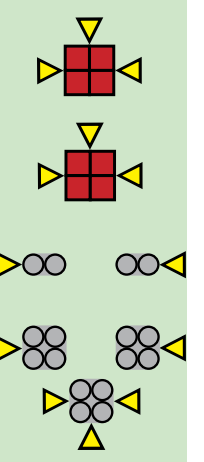
5

BB 41 RICHELIEU

Richelieu class '40-42



12 9 6

0 1
1 0

Broken Up '64

1 2 5
5 6 9
3 4 5
7 8 9

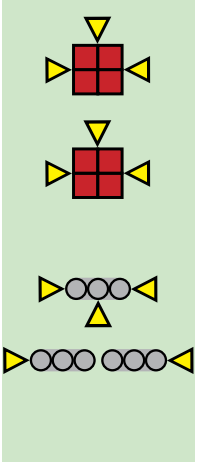
6

BB 41 RICHELIEU

Richelieu class '43-45

12 9 6

0 2
1 1

Broken Up '64

1 2 5
5 6 9
3 4 5
7 8 9

6

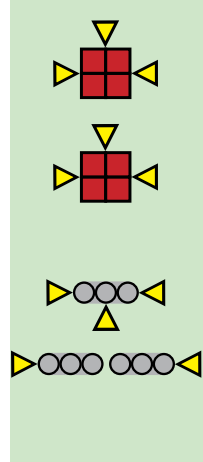
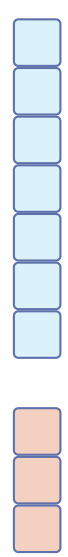
BB 30 JEAN BART

Richelieu class '40-42 (77% Complete)



6 5 4

0 1
0 0

Broken Up '70

5 6 9
7 8 9

6

BB 41 GASCOGNE

Modified Richelieu class



12 9 6

0 2
1 1

Never Laid Down

1 2 5
5 6 9
3 4 5
7 8 9

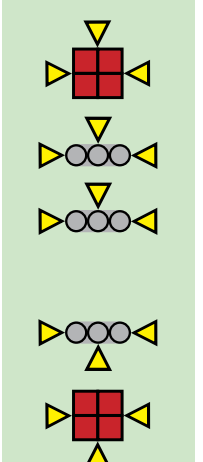
6

CV 15 BÉARN

Béarn class, '39-'43*

6 5 4 2

1 0

Sold for BU 31/03/67
* - Converted to Aircraft Transport '44-'45

4 2

READY AIRCRAFT

UNREADY AIRCRAFT

CV 20 JOFFRE

Joffre class '40

12 9 6 2

1 0

Cancelled (25% Complete)

6 3

READY AIRCRAFT

UNREADY AIRCRAFT

Béarn's Airgroup*

Dewoitine 5+	Vindicator 6
5+	5+ i
Levasseur 6	Levasseur 6
5+	5+

* - Presumed composition for Pre-War / Early War '39-'41
Optionally, swap Dewoitine for additional Vindicator

CV* 10 COMMANDANT TESTE

Commandant Teste class, '39-'42

6 5 4 1

1 0

Scuttled 27/11/42 / BU '50
* - Seaplane Carrier

2 1

READY AIRCRAFT

UNREADY AIRCRAFT

Teste's Airgroup*

Latécoère 6	Loire 6
5+	5+ i

* - Presumed composition for Pre-War / Early War '39-'41
Both 1 pt each

Joffre's Airgroup*

Dewoitine 4+	Dewoitine 4+
6	6
Bréguet 6	Bréguet 6
5+ i	5+ i
Bréguet 6	Bréguet 6
5+ i	5+ i

* - Planned composition of the Airgroup for '39-'41
Dewoitine D.790 - carrier-borne variant of D.520
Bréguet Br.810 - carrier-borne variant of Br.693
Both didn't go into mass production

FR CR **11** **DUQUESNE**

Duquesne class '39-'45

12 9 6

0 1
1 0

Broken Up '55

2 3 6
4 5 6

1 2 3 4 5 6

0

FR CR **11** **TOURVILLE**

Duquesne class '39-'45

12 9 6

0 1
1 0

Broken Up '62

2 3 6
4 5 6

1 2 3 4 5 6

0

FR CR **14** **SUFFREN**

Suffren class '39-'43

12 9 6

0 1
1 0

Broken Up '74

2 3 6
4 5 6

1 2 3 4 5 6

1

FR CR **14** **SUFFREN**

Suffren class '44-'45

12 9 6

0 2
1 1

Broken Up '74

2 3 6
4 5 6

1 2 3 4 5 6

1

FR CR **14** **COLBERT**

Suffren class '39-'40

12 9 6

0 0
1 0

Scuttled 27/11/42

2 3 6
4 5 6

1 2 3 4 5 6

1

FR CR **14** **COLBERT**

Suffren class '41-'42

12 9 6

0 1
1 0

Scuttled 27/11/42

2 3 6
4 5 6

1 2 3 4 5 6

1

FR CR **14** **FOCH**

Suffren class '39-40

12 9 6

0 0
1 0

Scuttled 27/11/42

2 3 6
4 5 6

1

FR CR **14** **FOCH**

Suffren class '41-42

12 9 6

0 1
1 0

Scuttled 27/11/42

2 3 6
4 5 6

1

FR CR **14** **DUPLEIX**

Suffren class '39-40

12 9 6

0 0
1 0

Scuttled 27/11/42

2 3 6
4 5 6

1

FR CR **14** **DUPLEIX**

Suffren class '41-42

12 9 6

0 1
1 0

Scuttled 27/11/42

2 3 6
4 5 6

1

FR CR **20** **ALGÉRIE**

Algérie class '39-42

12 9 6

0 1
1 0

Scuttled 27/11/42

2 3 6
4 5 6

3

FR CR **6** **DUGUAY-TROUIN**

Duguay-Trouin class '39-41

12 9 6

0 0
1 0

Broken Up '52

1 2 5
3 4 5

0

FR CR **6** **DUGUAY-TROUIN**

Duguay-Trouin class '43

12 9 6

0 0

1 0

Broken Up '52

1 2 5

3 4 5

0

FR CR **6** **DUGUAY-TROUIN**

Duguay-Trouin class '44-'45

12 9 6

0 1

1 0

Broken Up '52

1 2 5

3 4 5

0

FR CR **6** **LAMOTTE-PICQUET**

Duguay-Trouin class '39-'42

12 9 6

0 0

1 0

Sunk 12/01/45

1 2 5

3 4 5

0

FR CR **6** **PRIMAUGUET**

Duguay-Trouin class '39-'40

12 9 6

0 0

1 0

Beached 08/11/42

1 2 5

3 4 5

0

FR CR **6** **PRIMAUGUET**

Duguay-Trouin class '41-'42

12 9 6

0 0

1 0

Beached 08/11/42

1 2 5

3 4 5

0

FR CR **6** **PLUTON**

Pluton class '39

12 9 6

0 1

1 0

Sunk 13/09/39

0 1 4

2 3 4

0

FR **CR 6** **JEANNE D'ARC**

Jeanne d'Arc class '39-'43

9 6 4

0 0

1 0

Broken Up '66

1 2 5

3 4 5

0

FR **CR 6** **JEANNE D'ARC**

Jeanne d'Arc class '44-'45

9 6 4

0 1

1 0

Broken Up '66

1 2 5

3 4 5

0

FR **CR 7** **ÉMILE BERTIN**

Émile Bertin class '39-'43

12 9 6

0 0

1 0

Broken Up '59

1 2 5

3 4 5

0

FR **CR 7** **ÉMILE BERTIN**

Émile Bertin class '44-'45

12 9 6

0 2

1 1

Broken Up '59

1 2 5

3 4 5

0

FR **CR 10** **LA GALISSONNIÈRE**

La Galissonnière class '39-'40

12 9 6

0 0

1 0

Scuttled 27/11/42

1 2 5

3 4 5

3

FR **CR 10** **LA GALISSONNIÈRE**

La Galissonnière class '41-'42

12 9 6

0 1

1 0

Scuttled 27/11/42

1 2 5

3 4 5

3

FR CR **10** **JEAN DE VIENNE**

La Galissonnière class '39-'40

12 9 6

0 0
1 0

Scuttled 27/11/42

1 2 5
3 4 5

• • •
• • • •
• • • • •

3

FR CR **10** **JEAN DE VIENNE**

La Galissonnière class '41-'42

12 9 6

0 1
1 0

Scuttled 27/11/42

1 2 5
3 4 5

• • •
• • • •
• • • • •

3

FR CR **10** **MARSEILLAISE**

La Galissonnière class '39-'42

12 9 6

0 0
1 0

Scuttled 27/11/42

1 2 5
3 4 5

• • •
• • • •
• • • • •

3

FR CR **10** **GLOIRE**

La Galissonnière class '39-'43

12 9 6

0 0
1 0

Sold for BU '58

1 2 5
3 4 5

• • •
• • • •
• • • • •

3

FR CR **10** **GLOIRE**

La Galissonnière class '44-'45

12 9 6

0 2
1 1

Sold for BU '58

1 2 5
3 4 5

• • •
• • • •
• • • • •

3

FR CR **10** **MONTCALM**

La Galissonnière class '39-'42

12 9 6

0 0
1 0

Broken Up '70

1 2 5
3 4 5

• • •
• • • •
• • • • •

3

FR **CR 10** **MONTCALM**

La Galissonnière class '43-'45

0 2
1 1

12 9 6

Broken Up '70

1 2 5
3 4 5

3

FR **CR 10** **GEORGES LEYGUES**

La Galissonnière class '39-'43

0 0
1 0

12 9 6

Sold for BU '59

1 2 5
3 4 5

3

FR **CR 10** **GEORGES LEYGUES**

La Galissonnière class '44-'45

0 2
1 1

12 9 6

Sold for BU '59

1 2 5
3 4 5

3

FR **CR 23** **SAINT LOUIS**

Projected Saint Louis class '40+ C5 SA1

0 2
1 1

12 9 6

Never Laid Down

2 3 6
4 5 6

4

FR **CR 10** **DE GRASSE**

Improved La Galissonnière class

0 1
1 0

12 9 6

Captured in '40 (28% Complete)
Construction Resumed in '46
Built as AA Cruiser in '56
Broken Up '76

1 2 5
3 4 5

3

DD 2 JAGUAR

Chacal class '39-40

12 6

0 0
1 0

Sunk 23/05/40

0 1 4
2 3 4

DD 2 LYNX

Chacal class '39-42

12 6

0 0
1 0

Scuttled 27/11/42

0 1 4
2 3 4

DD 2 TIGRE

Chacal class '39-42

12 6

0 0
1 0

Broken Up '54

0 1 4
2 3 4

DD 2 TIGRE

Chacal class '44-45

9 6

0 1
1 0

Broken Up '54

0 1 4
2 3 4

DD 2 CHACAL

Chacal class '39-40

12 6

0 0
1 0

Sunk 24/05/40

0 1 4
2 3 4

DD 2 LÉOPARD

Chacal class '39-40

12 6

0 0
1 0

Wrecked 27/05/43

0 1 4
2 3 4

DD 2 LÉOPARD

Chacal class '41-43

9 6

0 1
1 0

Wrecked 27/05/43

0 1 4
2 3 4

DD 2 PANTHÈRE

Chacal class '39-42

12 6

0 0
1 0

Seized 11/42 / Scuttled 09/43

0 1 4
2 3 4

DD 2 GUÉPARD

Guépard class '39-40

12 6

0 0
1 0

Scuttled 27/11/42

0 1 4
2 3 4

DD 2 GUÉPARD

Guépard class '41-42

12 6

0 0
1 0

Scuttled 27/11/42

0 1 4
2 3 4

DD 2 VALMY

Guépard class '39-40

12 6

0 0
1 0

Scuttled 27/11/42

0 1 4
2 3 4

DD 2 VALMY

Guépard class '41-42

12 6

0 0
1 0

Scuttled 27/11/42

0 1 4
2 3 4

DD 2 VERDUN

Guépard class '39-40

12 6

0 0
1 0

0 1 4
2 3 4

0

DD 2 VERDUN

Guépard class '41-42

12 6

0 0
1 0

0 1 4
2 3 4

0

DD 2 BISON

Guépard class '39-40

12 6

0 0
1 0

0 1 4
2 3 4

0

DD 2 LION

Guépard class '39-42

12 6

0 0
1 0

0 1 4
2 3 4

0

DD 2 VAUBAN

Guépard class '39-42

12 6

0 0
1 0

0 1 4
2 3 4

0

DD 3 AIGLE

Aigle class '39-42

12 6

0 0
1 0

0 1 4
2 3 4

0

DD 3 GERFAUT

Aigle class '39-42

12 6

0 0
1 0

0 1 4
2 3 4

0

DD 3 ALBATROS

Aigle class '39-42

12 6

0 0
1 0

0 1 4
2 3 4

0

Beached 08/11/42 / BU '59

DD 3 VAUTOUR

Aigle class '39-42

12 6

0 0
1 0

0 1 4
2 3 4

0

DD 3 ÉPERVIER

Aigle class '39-40

12 6

0 0
1 0

0 1 4
2 3 4

0

Beached 09/11/42

DD 3 ÉPERVIER

Aigle class '41-42

12 6

0 1
1 0

0 1 4
2 3 4

0

Beached 09/11/42

DD 3 MILAN

Aigle class '39-40

12 6

0 0
1 0

0 1 4
2 3 4

0

Beached 08/11/42

	DD	3	MILAN
<i>Aigle class '41-42</i>			
<i>Beached 08/11/42</i>			

	DD	3	VAUQUELIN
<i>Vauquelin class '39-40</i>			
<i>Scuttled 27/11/42</i>			

	DD	3	VAUQUELIN
<i>Vauquelin class '41-42</i>			
<i>Scuttled 27/11/42</i>			

	DD	3	CASSARD
<i>Vauquelin class '39-40</i>			
<i>Scuttled 27/11/42</i>			

	DD	3	CASSARD
<i>Vauquelin class '41-42</i>			
<i>Scuttled 27/11/42</i>			

	DD	3	MAILLÉ BRÉZÉ
<i>Vauquelin class '39-40</i>			
<i>Sunk 30/04/40</i>			

	DD	3	KERSAINT
<i>Vauquelin class '39-40</i>			
<i>Scuttled 27/11/42</i>			

	DD	3	KERSAINT
<i>Vauquelin class '41-42</i>			
<i>Scuttled 27/11/42</i>			

	DD	3	TARTU
<i>Vauquelin class '39-40</i>			
<i>Scuttled 27/11/42</i>			

	DD	3	TARTU
<i>Vauquelin class '41-42</i>			
<i>Scuttled 27/11/42</i>			

	DD	3	CHEVALIER PAUL
<i>Vauquelin class '39</i>			
<i>Sunk 16/06/41</i>			

	DD	3	CHEVALIER PAUL
<i>Vauquelin class '40-41</i>			
<i>Sunk 16/06/41</i>			

DD 4 LE MALIN

Le Fantasque class '39-43

12 6

0 0
1 0

Broken Up '64

0 1 4
2 3 4

Diagram showing a ship layout with a hull of 4 cells, a superstructure of 4 cells, and a deck of 4 cells. The hull is marked with yellow triangles. The superstructure is marked with yellow triangles. The deck is marked with blue circles. A small grey square with the number 0 is shown at the bottom right.

DD 4 LE MALIN

Le Fantasque class '44-45

12 6

0 1
1 0

Broken Up '64

0 1 4
2 3 4

Diagram showing a ship layout with a hull of 4 cells, a superstructure of 4 cells, and a deck of 4 cells. The hull is marked with yellow triangles. The superstructure is marked with yellow triangles. The deck is marked with blue circles. A small grey square with the number 0 is shown at the bottom right.

DD 4 LE TERRIBLE

Le Fantasque class '39-43

12 6

0 0
1 0

Broken Up '62

0 1 4
2 3 4

Diagram showing a ship layout with a hull of 4 cells, a superstructure of 4 cells, and a deck of 4 cells. The hull is marked with yellow triangles. The superstructure is marked with yellow triangles. The deck is marked with blue circles. A small grey square with the number 0 is shown at the bottom right.

DD 4 LE TERRIBLE

Le Fantasque class '44-45

12 6

0 1
1 0

Broken Up '62

0 1 4
2 3 4

Diagram showing a ship layout with a hull of 4 cells, a superstructure of 4 cells, and a deck of 4 cells. The hull is marked with yellow triangles. The superstructure is marked with yellow triangles. The deck is marked with blue circles. A small grey square with the number 0 is shown at the bottom right.

DD 4 L'INDOMPTABLE

Le Fantasque class '39-42

12 6

0 0
1 0

Scuttled 27/11/42

0 1 4
2 3 4

Diagram showing a ship layout with a hull of 4 cells, a superstructure of 4 cells, and a deck of 4 cells. The hull is marked with yellow triangles. The superstructure is marked with yellow triangles. The deck is marked with blue circles. A small grey square with the number 0 is shown at the bottom right.

DD 4 L'AUDACIEUX

Le Fantasque class '39-42

12 6

0 0
1 0

Scuttled 27/11/42

0 1 4
2 3 4

Diagram showing a ship layout with a hull of 4 cells, a superstructure of 4 cells, and a deck of 4 cells. The hull is marked with yellow triangles. The superstructure is marked with yellow triangles. The deck is marked with blue circles. A small grey square with the number 0 is shown at the bottom right.

DD 4 LE FANTASQUE

Le Fantasque class '39-42

12 6

0 0
1 0

Stricken '57

0 1 4
2 3 4

Diagram showing a ship layout with a hull of 4 cells, a superstructure of 4 cells, and a deck of 4 cells. The hull is marked with yellow triangles. The superstructure is marked with yellow triangles. The deck is marked with blue circles. A small grey square with the number 0 is shown at the bottom right.

DD 4 LE FANTASQUE

Le Fantasque class '43-45

12 6

0 1
1 0

Stricken '57

0 1 4
2 3 4

Diagram showing a ship layout with a hull of 4 cells, a superstructure of 4 cells, and a deck of 4 cells. The hull is marked with yellow triangles. The superstructure is marked with yellow triangles. The deck is marked with blue circles. A small grey square with the number 0 is shown at the bottom right.

DD 4 LE TRIOMPHANT

Le Fantasque class '39-40

12 6

0 0
1 0

Stricken '54

0 1 4
2 3 4

Diagram showing a ship layout with a hull of 4 cells, a superstructure of 4 cells, and a deck of 4 cells. The hull is marked with yellow triangles. The superstructure is marked with yellow triangles. The deck is marked with blue circles. A small grey square with the number 0 is shown at the bottom right.

DD 4 LE TRIOMPHANT

Le Fantasque class '41-44

12 6

0 1
1 0

Stricken '54

0 1 4
2 3 4

Diagram showing a ship layout with a hull of 4 cells, a superstructure of 4 cells, and a deck of 4 cells. The hull is marked with yellow triangles. The superstructure is marked with yellow triangles. The deck is marked with blue circles. A small grey square with the number 0 is shown at the bottom right.

DD 4 LE TRIOMPHANT

Le Fantasque class '45

12 6

0 1
1 0

Stricken '54

0 1 4
2 3 4

Diagram showing a ship layout with a hull of 4 cells, a superstructure of 4 cells, and a deck of 4 cells. The hull is marked with yellow triangles. The superstructure is marked with yellow triangles. The deck is marked with blue circles. A small grey square with the number 0 is shown at the bottom right.

DD 5 VOLTA

Mogador class '39-42

12 6

0 1
1 0

Scuttled 27/11/42

0 1 4
2 3 4

Diagram showing a ship layout with a hull of 4 cells, a superstructure of 4 cells, and a deck of 4 cells. The hull is marked with yellow triangles. The superstructure is marked with yellow triangles. The deck is marked with blue circles. A small grey square with the number 0 is shown at the bottom right.

<p>DD 5 MOGADOR</p> <p><i>Mogador class '39-42</i></p> <p>Scuttled 27/11/42</p>	<p>DD 5 KLÉBER</p> <p><i>Improved Mogador class '40</i></p> <p>Never Laid Down</p>	<p>DD 2 TYPHON</p> <p><i>Bourrasque class '39</i></p> <p>Scuttled 09/11/42</p>	<p>DD 2 TYPHON</p> <p><i>Bourrasque class '40</i></p> <p>Scuttled 09/11/42</p>
<p>DD 2 TYPHON</p> <p><i>Bourrasque class '41-42</i></p> <p>Scuttled 09/11/42</p>	<p>DD 2 SIMOUN</p> <p><i>Bourrasque class '39</i></p> <p>Sold for BU '50</p>	<p>DD 2 SIMOUN</p> <p><i>Bourrasque class '40-42</i></p> <p>Sold for BU '50</p>	<p>DD 2 SIMOUN</p> <p><i>Bourrasque class '43</i></p> <p>Sold for BU '50</p>
<p>DD 2 SIMOUN</p> <p><i>Bourrasque class '44-45</i></p> <p>Sold for BU '50</p>	<p>DD 2 ORAGE</p> <p><i>Bourrasque class '39</i></p> <p>Scuttled 23/05/40</p>	<p>DD 2 ORAGE</p> <p><i>Bourrasque class '40</i></p> <p>Scuttled 23/05/40</p>	<p>DD 2 TRAMONTANE</p> <p><i>Bourrasque class '39</i></p> <p>Beached 08/11/42</p>

	DD	2	TRAMONTANE
<i>Bourrasque class '40</i>			
0	0		
1	0		
<i>Beached 08/11/42</i>			
0	1	4	
2	3	4	

	DD	2	TRAMONTANE
<i>Bourrasque class '41-42</i>			
0	0		
1	0		
<i>Beached 08/11/42</i>			
0	1	4	
2	3	4	

	DD	2	OURAGAN
<i>Bourrasque class '39</i>			
0	0		
1	0		
<i>Sold for BU '49</i>			
0	1	4	
2	3	4	

	DD	2	OURAGAN
<i>Bourrasque class '40-42</i>			
0	0		
1	0		
<i>Sold for BU '49</i>			
0	1	4	
2	3	4	

	DD	2	OURAGAN
<i>Bourrasque class '43-45</i>			
0	1		
1	0		
<i>Sold for BU '49</i>			
0	0	3	
1	2	3	

	DD	2	CYCLONE
<i>Bourrasque class '39-40</i>			
0	0		
1	0		
<i>Scuttled 18/06/40</i>			
0	1	4	
2	3	4	

	DD	2	TEMPÊTE
<i>Bourrasque class '39-42</i>			
0	0		
1	0		
<i>Broken Up '50</i>			
0	1	4	
2	3	4	

	DD	2	TEMPÊTE
<i>Bourrasque class '43-45</i>			
0	0		
1	0		
<i>Broken Up '50</i>			
0	1	4	
2	3	4	

	DD	2	MISTRAL
<i>Bourrasque class '39</i>			
0	0		
1	0		
<i>Broken Up '50</i>			
0	1	4	
2	3	4	

	DD	2	MISTRAL
<i>Bourrasque class '40-42</i>			
0	0		
1	0		
<i>Broken Up '50</i>			
0	1	4	
2	3	4	

	DD	2	MISTRAL
<i>Bourrasque class '43-45</i>			
0	1		
1	0		
<i>Not Operational Since '44 / BU '50</i>			
0	0	3	
1	2	3	

	DD	2	TORNÂDE
<i>Bourrasque class '39</i>			
0	0		
1	0		
<i>Sunk 08/11/42</i>			
0	1	4	
2	3	4	

DD 2 TORNADE

Bourrasque class '40













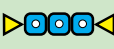





9 6

0	0
1	0

Sunk 08/11/42

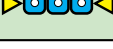
0	1	4
2	3	4

DD 2 TORNADE

Bourrasque class '41-42













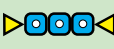





9 6

0	0
1	0

Sunk 08/11/42

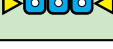
0	1	4
2	3	4

DD 2 BOURRASQUE

Bourrasque class '39













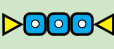





9 6

0	0
1	0

Sunk 30/05/40

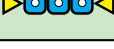
0	1	4
2	3	4

DD 2 BOURRASQUE

Bourrasque class '40













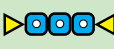





9 6

0	0
1	0

Sunk 30/05/40

0	1	4
2	3	4

DD 2 SIROCCO

Bourrasque class '39-40











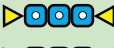

9 6

0	0
1	0

Sunk 31/05/40

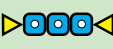
0	1	4
2	3	4

DD 2 TROMBE

Bourrasque class '39











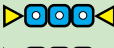

9 6

0	0
1	0

Scuttled 27/11/42 / BU '50

0	1	4
2	3	4

DD 2 TROMBE

Bourrasque class '40-42











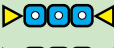

9 6

0	0
1	0

Scuttled 27/11/42 / BU '50

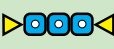
0	1	4
2	3	4

DD 2 L'ALCYON

L'Adroit class '39 / '41-42













9 6

0	0
1	0

Sold for BU '52

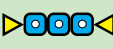
0	1	4
2	3	4

DD 2 L'ALCYON

L'Adroit class '40 / '43







9 6

0	0
1	0

Sold for BU '52

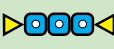
0	1	4
2	3	4

DD 2 L'ALCYON

L'Adroit class '44-45









9 6

0	0
1	0

Sold for BU '52

0	1	4
2	3	4

DD 2 LA PALME

L'Adroit class '39-42







9 6

0	0
1	0

Scuttled 27/11/42

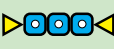
0	1	4
2	3	4

DD 2 LE MARS

L'Adroit class '39 / '41-42







9 6

0	0
1	0

Scuttled 27/11/42

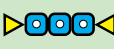
0	1	4
2	3	4

	DD	2	LE MARS
<p><i>L'Adroit class '40</i></p>			
<p>Scuttled 27/11/42</p>			

	DD	2	LA RAILLEUSE
<p><i>L'Adroit class '39</i></p>			
<p>Sunk 24/03/40</p>			

	DD	2	LA RAILLEUSE
<p><i>L'Adroit class '40</i></p>			
<p>Sunk 24/03/40</p>			

	DD	2	LE FORTUNÉ
<p><i>L'Adroit class '39 / '41-'42</i></p>			
<p>Sold for BU '50</p>			

	DD	2	LE FORTUNÉ
<p><i>L'Adroit class '40 / '43</i></p>			
<p>Sold for BU '50</p>			

	DD	2	LE FORTUNÉ
<p><i>L'Adroit class '44-'45</i></p>			
<p>Sold for BU '50</p>			

	DD	2	L'ADROIT
<p><i>L'Adroit class '39</i></p>			
<p>Sunk 21/05/40</p>			

	DD	2	L'ADROIT
<p><i>L'Adroit class '40</i></p>			
<p>Sunk 21/05/40</p>			

	DD	2	BRETOIS
<p><i>L'Adroit class '39-'42</i></p>			
<p>Sunk 08/11/42</p>			

	DD	2	BORDELAIS
<p><i>L'Adroit class '39 / '41-'42</i></p>			
<p>Scuttled 27/11/42</p>			

	DD	2	BORDELAIS
<p><i>L'Adroit class '40</i></p>			
<p>Scuttled 27/11/42</p>			

	DD	2	BOULONNAIS
<p><i>L'Adroit class '39-'42</i></p>			
<p>Sunk 08/11/42</p>			

	DD	2	FORBIN																		
<i>L'Adroit class '39-42</i>																					
<table border="1"> <tr><td>9</td><td>6</td></tr> <tr><td>0</td><td>0</td></tr> <tr><td>1</td><td>0</td></tr> </table>		9	6	0	0	1	0	<table border="1"> <tr><td> </td><td> </td><td> </td></tr> <tr><td> </td><td> </td><td> </td></tr> <tr><td> </td><td> </td><td> </td></tr> </table>													
9	6																				
0	0																				
1	0																				
<i>Sold for BU '52</i>																					
<table border="1"> <tr><td>0</td><td>1</td><td>4</td></tr> <tr><td>2</td><td>3</td><td>4</td></tr> <tr><td></td><td></td><td></td></tr> </table>		0	1	4	2	3	4				<table border="1"> <tr><td> </td><td> </td><td> </td></tr> <tr><td> </td><td> </td><td> </td></tr> <tr><td> </td><td> </td><td> </td></tr> </table>										
0	1	4																			
2	3	4																			

	DD	2	FORBIN																		
<i>L'Adroit class '43</i>																					
<table border="1"> <tr><td>9</td><td>6</td></tr> <tr><td>0</td><td>0</td></tr> <tr><td>1</td><td>0</td></tr> </table>		9	6	0	0	1	0	<table border="1"> <tr><td> </td><td> </td><td> </td></tr> <tr><td> </td><td> </td><td> </td></tr> <tr><td> </td><td> </td><td> </td></tr> </table>													
9	6																				
0	0																				
1	0																				
<i>Sold for BU '52</i>																					
<table border="1"> <tr><td>0</td><td>1</td><td>4</td></tr> <tr><td>2</td><td>3</td><td>4</td></tr> <tr><td></td><td></td><td></td></tr> </table>		0	1	4	2	3	4				<table border="1"> <tr><td> </td><td> </td><td> </td></tr> <tr><td> </td><td> </td><td> </td></tr> <tr><td> </td><td> </td><td> </td></tr> </table>										
0	1	4																			
2	3	4																			

	DD	2	FORBIN																		
<i>L'Adroit class '44-45</i>																					
<table border="1"> <tr><td>9</td><td>6</td></tr> <tr><td>0</td><td>0</td></tr> <tr><td>1</td><td>0</td></tr> </table>		9	6	0	0	1	0	<table border="1"> <tr><td> </td><td> </td><td> </td></tr> <tr><td> </td><td> </td><td> </td></tr> <tr><td> </td><td> </td><td> </td></tr> </table>													
9	6																				
0	0																				
1	0																				
<i>Sold for BU '52</i>																					
<table border="1"> <tr><td>0</td><td>1</td><td>4</td></tr> <tr><td>2</td><td>3</td><td>4</td></tr> <tr><td></td><td></td><td></td></tr> </table>		0	1	4	2	3	4				<table border="1"> <tr><td> </td><td> </td><td> </td></tr> <tr><td> </td><td> </td><td> </td></tr> <tr><td> </td><td> </td><td> </td></tr> </table>										
0	1	4																			
2	3	4																			

	DD	2	FOUGUEUX																		
<i>L'Adroit class '39-42</i>																					
<table border="1"> <tr><td>9</td><td>6</td></tr> <tr><td>0</td><td>0</td></tr> <tr><td>1</td><td>0</td></tr> </table>		9	6	0	0	1	0	<table border="1"> <tr><td> </td><td> </td><td> </td></tr> <tr><td> </td><td> </td><td> </td></tr> <tr><td> </td><td> </td><td> </td></tr> </table>													
9	6																				
0	0																				
1	0																				
<i>Sunk 08/11/42</i>																					
<table border="1"> <tr><td>0</td><td>1</td><td>4</td></tr> <tr><td>2</td><td>3</td><td>4</td></tr> <tr><td></td><td></td><td></td></tr> </table>		0	1	4	2	3	4				<table border="1"> <tr><td> </td><td> </td><td> </td></tr> <tr><td> </td><td> </td><td> </td></tr> <tr><td> </td><td> </td><td> </td></tr> </table>										
0	1	4																			
2	3	4																			

	DD	2	FOUDROYANT																		
<i>L'Adroit class '39-40</i>																					
<table border="1"> <tr><td>9</td><td>6</td></tr> <tr><td>0</td><td>0</td></tr> <tr><td>1</td><td>0</td></tr> </table>		9	6	0	0	1	0	<table border="1"> <tr><td> </td><td> </td><td> </td></tr> <tr><td> </td><td> </td><td> </td></tr> <tr><td> </td><td> </td><td> </td></tr> </table>													
9	6																				
0	0																				
1	0																				
<i>Sunk 01/06/40</i>																					
<table border="1"> <tr><td>0</td><td>1</td><td>4</td></tr> <tr><td>2</td><td>3</td><td>4</td></tr> <tr><td></td><td></td><td></td></tr> </table>		0	1	4	2	3	4				<table border="1"> <tr><td> </td><td> </td><td> </td></tr> <tr><td> </td><td> </td><td> </td></tr> <tr><td> </td><td> </td><td> </td></tr> </table>										
0	1	4																			
2	3	4																			

	DD	2	BASQUE																		
<i>L'Adroit class '39 / '41-42</i>																					
<table border="1"> <tr><td>9</td><td>6</td></tr> <tr><td>0</td><td>0</td></tr> <tr><td>1</td><td>0</td></tr> </table>		9	6	0	0	1	0	<table border="1"> <tr><td> </td><td> </td><td> </td></tr> <tr><td> </td><td> </td><td> </td></tr> <tr><td> </td><td> </td><td> </td></tr> </table>													
9	6																				
0	0																				
1	0																				
<i>Sold for BU '52</i>																					
<table border="1"> <tr><td>0</td><td>1</td><td>4</td></tr> <tr><td>2</td><td>3</td><td>4</td></tr> <tr><td></td><td></td><td></td></tr> </table>		0	1	4	2	3	4				<table border="1"> <tr><td> </td><td> </td><td> </td></tr> <tr><td> </td><td> </td><td> </td></tr> <tr><td> </td><td> </td><td> </td></tr> </table>										
0	1	4																			
2	3	4																			

	DD	2	BASQUE																		
<i>L'Adroit class '40 / '43</i>																					
<table border="1"> <tr><td>9</td><td>6</td></tr> <tr><td>0</td><td>0</td></tr> <tr><td>1</td><td>0</td></tr> </table>		9	6	0	0	1	0	<table border="1"> <tr><td> </td><td> </td><td> </td></tr> <tr><td> </td><td> </td><td> </td></tr> <tr><td> </td><td> </td><td> </td></tr> </table>													
9	6																				
0	0																				
1	0																				
<i>Sold for BU '52</i>																					
<table border="1"> <tr><td>0</td><td>1</td><td>4</td></tr> <tr><td>2</td><td>3</td><td>4</td></tr> <tr><td></td><td></td><td></td></tr> </table>		0	1	4	2	3	4				<table border="1"> <tr><td> </td><td> </td><td> </td></tr> <tr><td> </td><td> </td><td> </td></tr> <tr><td> </td><td> </td><td> </td></tr> </table>										
0	1	4																			
2	3	4																			

	DD	2	BASQUE																		
<i>L'Adroit class '44-45</i>																					
<table border="1"> <tr><td>9</td><td>6</td></tr> <tr><td>0</td><td>0</td></tr> <tr><td>1</td><td>0</td></tr> </table>		9	6	0	0	1	0	<table border="1"> <tr><td> </td><td> </td><td> </td></tr> <tr><td> </td><td> </td><td> </td></tr> <tr><td> </td><td> </td><td> </td></tr> </table>													
9	6																				
0	0																				
1	0																				
<i>Sold for BU '52</i>																					
<table border="1"> <tr><td>0</td><td>1</td><td>4</td></tr> <tr><td>2</td><td>3</td><td>4</td></tr> <tr><td></td><td></td><td></td></tr> </table>		0	1	4	2	3	4				<table border="1"> <tr><td> </td><td> </td><td> </td></tr> <tr><td> </td><td> </td><td> </td></tr> <tr><td> </td><td> </td><td> </td></tr> </table>										
0	1	4																			
2	3	4																			

	DD	2	FRONDEUR																		
<i>L'Adroit class '39-42</i>																					
<table border="1"> <tr><td>9</td><td>6</td></tr> <tr><td>0</td><td>0</td></tr> <tr><td>1</td><td>0</td></tr> </table>		9	6	0	0	1	0	<table border="1"> <tr><td> </td><td> </td><td> </td></tr> <tr><td> </td><td> </td><td> </td></tr> <tr><td> </td><td> </td><td> </td></tr> </table>													
9	6																				
0	0																				
1	0																				
<i>Sunk 08/11/42</i>																					
<table border="1"> <tr><td>0</td><td>1</td><td>4</td></tr> <tr><td>2</td><td>3</td><td>4</td></tr> <tr><td></td><td></td><td></td></tr> </table>		0	1	4	2	3	4				<table border="1"> <tr><td> </td><td> </td><td> </td></tr> <tr><td> </td><td> </td><td> </td></tr> <tr><td> </td><td> </td><td> </td></tr> </table>										
0	1	4																			
2	3	4																			

	DD	3	LE HARDI																		
<i>Le Hardi class '40-42</i>																					
<table border="1"> <tr><td>12</td><td>6</td></tr> <tr><td>0</td><td>1</td></tr> <tr><td>1</td><td>0</td></tr> </table>		12	6	0	1	1	0	<table border="1"> <tr><td> </td><td> </td><td> </td></tr> <tr><td> </td><td> </td><td> </td></tr> <tr><td> </td><td> </td><td> </td></tr> </table>													
12	6																				
0	1																				
1	0																				
<i>Scuttled 27/11/42 & 24/04/45</i>																					
<table border="1"> <tr><td>0</td><td>1</td><td>4</td></tr> <tr><td>2</td><td>3</td><td>4</td></tr> <tr><td></td><td></td><td></td></tr> </table>		0	1	4	2	3	4				<table border="1"> <tr><td> </td><td> </td><td> </td></tr> <tr><td> </td><td> </td><td> </td></tr> <tr><td> </td><td> </td><td> </td></tr> </table>										
0	1	4																			
2	3	4																			

	DD	3	FOUDROYANT <small>(ex-Fleuret, renamed 01/04/41)</small>																		
<i>Le Hardi class '40-42</i>																					
<table border="1"> <tr><td>12</td><td>6</td></tr> <tr><td>0</td><td>1</td></tr> <tr><td>1</td><td>0</td></tr> </table>		12	6	0	1	1	0	<table border="1"> <tr><td> </td><td> </td><td> </td></tr> <tr><td> </td><td> </td><td> </td></tr> <tr><td> </td><td> </td><td> </td></tr> </table>													
12	6																				
0	1																				
1	0																				
<i>Scuttled 27/11/42 & 08/44</i>																					
<table border="1"> <tr><td>0</td><td>1</td><td>4</td></tr> <tr><td>2</td><td>3</td><td>4</td></tr> <tr><td></td><td></td><td></td></tr> </table>		0	1	4	2	3	4				<table border="1"> <tr><td> </td><td> </td><td> </td></tr> <tr><td> </td><td> </td><td> </td></tr> <tr><td> </td><td> </td><td> </td></tr> </table>										
0	1	4																			
2	3	4																			

	DD	3	L'ADROIT <small>(ex-Épée, renamed 29/03/41)</small>																		
<i>Le Hardi class '40-42</i>																					
<table border="1"> <tr><td>12</td><td>6</td></tr> <tr><td>0</td><td>1</td></tr> <tr><td>1</td><td>0</td></tr> </table>		12	6	0	1	1	0	<table border="1"> <tr><td> </td><td> </td><td> </td></tr> <tr><td> </td><td> </td><td> </td></tr> <tr><td> </td><td> </td><td> </td></tr> </table>													
12	6																				
0	1																				
1	0																				
<i>Scuttled 27/11/42 & BU '44</i>																					
<table border="1"> <tr><td>0</td><td>1</td><td>4</td></tr> <tr><td>2</td><td>3</td><td>4</td></tr> <tr><td></td><td></td><td></td></tr> </table>		0	1	4	2	3	4				<table border="1"> <tr><td> </td><td> </td><td> </td></tr> <tr><td> </td><td> </td><td> </td></tr> <tr><td> </td><td> </td><td> </td></tr> </table>										
0	1	4																			
2	3	4																			

DD	3	CASQUE						
<i>Le Hardi class '40-42</i>  <table border="1"> <tr><td>12</td><td>6</td></tr> <tr><td>0</td><td>1</td></tr> <tr><td>1</td><td>0</td></tr> </table>			12	6	0	1	1	0
12	6							
0	1							
1	0							
Scuttled 27/11/42 / Sunk 04/44 <table border="1"> <tr><td>0</td><td>1</td><td>4</td></tr> <tr><td>2</td><td>3</td><td>4</td></tr> </table>			0	1	4	2	3	4
0	1	4						
2	3	4						

DD	3	LANSQUENET						
<i>Le Hardi class '41-42</i>  <table border="1"> <tr><td>12</td><td>6</td></tr> <tr><td>0</td><td>1</td></tr> <tr><td>1</td><td>0</td></tr> </table>			12	6	0	1	1	0
12	6							
0	1							
1	0							
Scuttled 27/11/42 / BU 09/58 <table border="1"> <tr><td>0</td><td>1</td><td>4</td></tr> <tr><td>2</td><td>3</td><td>4</td></tr> </table>			0	1	4	2	3	4
0	1	4						
2	3	4						

DD	3	MAMELUK						
<i>Le Hardi class '40-42</i>  <table border="1"> <tr><td>12</td><td>6</td></tr> <tr><td>0</td><td>1</td></tr> <tr><td>1</td><td>0</td></tr> </table>			12	6	0	1	1	0
12	6							
0	1							
1	0							
Scuttled 27/11/42 / BU '58 <table border="1"> <tr><td>0</td><td>1</td><td>4</td></tr> <tr><td>2</td><td>3</td><td>4</td></tr> </table>			0	1	4	2	3	4
0	1	4						
2	3	4						

DD	3	SIROCCO <small>(ex-Le Corsaire, renamed 01/04/41)</small>						
<i>Le Hardi class '41-42 (Incomplete)</i>  <table border="1"> <tr><td>12</td><td>6</td></tr> <tr><td>0</td><td>1</td></tr> <tr><td>1</td><td>0</td></tr> </table>			12	6	0	1	1	0
12	6							
0	1							
1	0							
Scuttled 27/11/42 & 20/10/44 <table border="1"> <tr><td>0</td><td>1</td><td>4</td></tr> <tr><td>2</td><td>3</td><td>4</td></tr> </table>			0	1	4	2	3	4
0	1	4						
2	3	4						

DD	3	BISON <small>(ex-Le Flibustier, renamed 01/04/41)</small>						
<i>Le Hardi class '41-42 (Incomplete)</i>  <table border="1"> <tr><td>12</td><td>6</td></tr> <tr><td>0</td><td>1</td></tr> <tr><td>1</td><td>0</td></tr> </table>			12	6	0	1	1	0
12	6							
0	1							
1	0							
Captured 27/11/42 / Sunk 08/44 <table border="1"> <tr><td>0</td><td>1</td><td>4</td></tr> <tr><td>2</td><td>3</td><td>4</td></tr> </table>			0	1	4	2	3	4
0	1	4						
2	3	4						

TB 1 LA MELPOMÈNE

La Melpomène class '39-42

12 6

0 0
1 0

Sold for BU '50

0 0 3
1 2 3

TB 1 LA MELPOMÈNE

La Melpomène class '43

12 6

0 0
1 0

Sold for BU '50

0 0 3
1 2 3

TB 1 LA POMONE

La Melpomène class '39-42

12 6

0 0
1 0

Scuttled 27/09/43

0 0 3
1 2 3

TB 1 LA POMONE

La Melpomène class '43

12 6

0 1
1 0

Scuttled 27/09/43

0 0 3
1 2 3

TB 1 LA FLORE

La Melpomène class '39-42

12 6

0 0
1 0

Sold for BU '50

0 0 3
1 2 3

TB 1 LA FLORE

La Melpomène class '43

12 6

0 0
1 0

Sold for BU '50

0 0 3
1 2 3

TB 1 L'IPHIGÉNIE

La Melpomène class '39-43

12 6

0 0
1 0

Sunk 10/09/43

0 0 3
1 2 3

TB 1 LA BAYONNAISE

La Melpomène class '39-42

12 6

0 0
1 0

Scuttled 27/11/42 & 25/08/44

0 0 3
1 2 3

TB 1 BOMBARDE

La Melpomène class '39-42

12 6

0 0
1 0

Sunk 23/08/44

0 0 3
1 2 3

TB 1 L'INCOMPRISE

La Melpomène class '39-42

12 6

0 0
1 0

Sold for BU '50

0 0 3
1 2 3

TB 1 L'INCOMPRISE

La Melpomène class '43

12 6

0 0
1 0

Sold for BU '50

0 0 3
1 2 3

TB 1 LA POURSUIVANTE

La Melpomène class '39-42

12 6

0 0
1 0

Scuttled 27/11/42

0 0 3
1 2 3

TB 1 LA CORDELIÈRE

La Melpomène class '39-42

12 6

0 0

1 0

Sold for BU '50

0 0 3

1 2 3

0

TB 1 LA CORDELIÈRE

La Melpomène class '43

12 6

0 0

1 0

Sold for BU '50

0 0 3

1 2 3

0

TB 1 BALISTE

La Melpomène class '39-42

12 6

0 0

1 0

Scuttled 27/11/42 / Sunk 22/08/43

0 0 3

1 2 3

0

TB 1 BRANLEBAS

La Melpomène class '39-40

12 6

0 0

1 0

Foundered 14/12/40

0 0 3

1 2 3

0

TB 1 BOUCLIER

La Melpomène class '39-42

12 6

0 0

1 0

Sold for BU '50

0 0 3

1 2 3

0

TB 1 BOUCLIER

La Melpomène class '43-45

12 6

0 0

1 0

Sold for BU '50

0 0 3

1 2 3

0

TB 2 LE FIER

Le Fier class '40-42

12 6

0 0

1 0

All 7 Scuttled Incomplete 08/44

0 0 3

1 2 3

0

DE 2 LA COMBATTANTE (ex-Haldon / RN)

Hunt class '42-45

9 4

0 1

1 0

Sunk 23/02/45

0 0 3

1 2 3

0

	CS	1	DUMONT D'URVILLE																			
<p><i>Bougainville class '39-42</i> Colonial Aviso (Sloop)</p> <p>6 4</p> <table border="1"> <tr><td>0</td><td>0</td></tr> <tr><td>1</td><td>0</td></tr> </table> <p>Sold for BU '58</p> <table border="1"> <tr><td>0</td><td>1</td><td>4</td></tr> <tr><td>2</td><td>3</td><td>4</td></tr> <tr><td>1</td><td>2</td><td>3</td></tr> <tr><td>1</td><td>2</td><td>3</td></tr> <tr><td>1</td><td>2</td><td>3</td></tr> </table>				0	0	1	0	0	1	4	2	3	4	1	2	3	1	2	3	1	2	3
0	0																					
1	0																					
0	1	4																				
2	3	4																				
1	2	3																				
1	2	3																				
1	2	3																				

	CS	1	DUMONT D'URVILLE																			
<p><i>Bougainville class '43-45</i> Colonial Aviso (Sloop)</p> <p>6 4</p> <table border="1"> <tr><td>0</td><td>1</td></tr> <tr><td>1</td><td>0</td></tr> </table> <p>Sold for BU '58</p> <table border="1"> <tr><td>0</td><td>1</td><td>4</td></tr> <tr><td>2</td><td>3</td><td>4</td></tr> <tr><td>1</td><td>2</td><td>3</td></tr> <tr><td>1</td><td>2</td><td>3</td></tr> <tr><td>1</td><td>2</td><td>3</td></tr> </table>				0	1	1	0	0	1	4	2	3	4	1	2	3	1	2	3	1	2	3
0	1																					
1	0																					
0	1	4																				
2	3	4																				
1	2	3																				
1	2	3																				
1	2	3																				

	CS	1	BOUGAINVILLE																			
<p><i>Bougainville class '39-40</i> Colonial Aviso (Sloop)</p> <p>6 4</p> <table border="1"> <tr><td>0</td><td>0</td></tr> <tr><td>1</td><td>0</td></tr> </table> <p>Sunk 09/11/40</p> <table border="1"> <tr><td>0</td><td>1</td><td>4</td></tr> <tr><td>2</td><td>3</td><td>4</td></tr> <tr><td>1</td><td>2</td><td>3</td></tr> <tr><td>1</td><td>2</td><td>3</td></tr> <tr><td>1</td><td>2</td><td>3</td></tr> </table>				0	0	1	0	0	1	4	2	3	4	1	2	3	1	2	3	1	2	3
0	0																					
1	0																					
0	1	4																				
2	3	4																				
1	2	3																				
1	2	3																				
1	2	3																				

	CS	1	SAVORGNAN DE BRAZZA																			
<p><i>Bougainville class '39-43</i> Colonial Aviso (Sloop)</p> <p>6 4</p> <table border="1"> <tr><td>0</td><td>0</td></tr> <tr><td>1</td><td>0</td></tr> </table> <p>Sold for BU '57</p> <table border="1"> <tr><td>0</td><td>1</td><td>4</td></tr> <tr><td>2</td><td>3</td><td>4</td></tr> <tr><td>1</td><td>2</td><td>3</td></tr> <tr><td>1</td><td>2</td><td>3</td></tr> <tr><td>1</td><td>2</td><td>3</td></tr> </table>				0	0	1	0	0	1	4	2	3	4	1	2	3	1	2	3	1	2	3
0	0																					
1	0																					
0	1	4																				
2	3	4																				
1	2	3																				
1	2	3																				
1	2	3																				

	CS	1	SAVORGNAN DE BRAZZA																			
<p><i>Bougainville class '44-45</i> Colonial Aviso (Sloop)</p> <p>6 4</p> <table border="1"> <tr><td>0</td><td>1</td></tr> <tr><td>1</td><td>0</td></tr> </table> <p>Sold for BU '57</p> <table border="1"> <tr><td>0</td><td>1</td><td>4</td></tr> <tr><td>2</td><td>3</td><td>4</td></tr> <tr><td>1</td><td>2</td><td>3</td></tr> <tr><td>1</td><td>2</td><td>3</td></tr> <tr><td>1</td><td>2</td><td>3</td></tr> </table>				0	1	1	0	0	1	4	2	3	4	1	2	3	1	2	3	1	2	3
0	1																					
1	0																					
0	1	4																				
2	3	4																				
1	2	3																				
1	2	3																				
1	2	3																				

	CS	1	D'ENTRECASTEAUX																			
<p><i>Bougainville class '39-42</i> Colonial Aviso (Sloop)</p> <p>6 4</p> <table border="1"> <tr><td>0</td><td>0</td></tr> <tr><td>1</td><td>0</td></tr> </table> <p>Beached 06/05/1942 / BU '48</p> <table border="1"> <tr><td>0</td><td>1</td><td>4</td></tr> <tr><td>2</td><td>3</td><td>4</td></tr> <tr><td>1</td><td>2</td><td>3</td></tr> <tr><td>1</td><td>2</td><td>3</td></tr> <tr><td>1</td><td>2</td><td>3</td></tr> </table>				0	0	1	0	0	1	4	2	3	4	1	2	3	1	2	3	1	2	3
0	0																					
1	0																					
0	1	4																				
2	3	4																				
1	2	3																				
1	2	3																				
1	2	3																				

	CS	1	RIGAUT DE GENOUILLY																			
<p><i>Bougainville class '39-40</i> Colonial Aviso (Sloop)</p> <p>6 4</p> <table border="1"> <tr><td>0</td><td>0</td></tr> <tr><td>1</td><td>0</td></tr> </table> <p>Sunk 04/07/40</p> <table border="1"> <tr><td>0</td><td>1</td><td>4</td></tr> <tr><td>2</td><td>3</td><td>4</td></tr> <tr><td>1</td><td>2</td><td>3</td></tr> <tr><td>1</td><td>2</td><td>3</td></tr> <tr><td>1</td><td>2</td><td>3</td></tr> </table>				0	0	1	0	0	1	4	2	3	4	1	2	3	1	2	3	1	2	3
0	0																					
1	0																					
0	1	4																				
2	3	4																				
1	2	3																				
1	2	3																				
1	2	3																				

	CS	1	AMIRAL CHARNER																			
<p><i>Bougainville class '39-45</i> Colonial Aviso (Sloop)</p> <p>6 4</p> <table border="1"> <tr><td>0</td><td>0</td></tr> <tr><td>1</td><td>0</td></tr> </table> <p>Scuttled 10/03/45</p> <table border="1"> <tr><td>0</td><td>1</td><td>4</td></tr> <tr><td>2</td><td>3</td><td>4</td></tr> <tr><td>1</td><td>2</td><td>3</td></tr> <tr><td>1</td><td>2</td><td>3</td></tr> <tr><td>1</td><td>2</td><td>3</td></tr> </table>				0	0	1	0	0	1	4	2	3	4	1	2	3	1	2	3	1	2	3
0	0																					
1	0																					
0	1	4																				
2	3	4																				
1	2	3																				
1	2	3																				
1	2	3																				

	CS	1	D'IBERVILLE																			
<p><i>Bougainville class '39-42</i> Colonial Aviso (Sloop)</p> <p>6 4</p> <table border="1"> <tr><td>0</td><td>0</td></tr> <tr><td>1</td><td>0</td></tr> </table> <p>Scuttled 27/11/42</p> <table border="1"> <tr><td>0</td><td>1</td><td>4</td></tr> <tr><td>2</td><td>3</td><td>4</td></tr> <tr><td>1</td><td>2</td><td>3</td></tr> <tr><td>1</td><td>2</td><td>3</td></tr> <tr><td>1</td><td>2</td><td>3</td></tr> </table>				0	0	1	0	0	1	4	2	3	4	1	2	3	1	2	3	1	2	3
0	0																					
1	0																					
0	1	4																				
2	3	4																				
1	2	3																				
1	2	3																				
1	2	3																				

	CS	1	LA GRANDIÈRE (ex-Ville d'Ys, renamed 01/04/40)																			
<p><i>Bougainville class '39-43</i> Colonial Aviso (Sloop)</p> <p>6 4</p> <table border="1"> <tr><td>0</td><td>0</td></tr> <tr><td>1</td><td>0</td></tr> </table> <p>Sold for BU '59</p> <table border="1"> <tr><td>0</td><td>1</td><td>4</td></tr> <tr><td>2</td><td>3</td><td>4</td></tr> <tr><td>1</td><td>2</td><td>3</td></tr> <tr><td>1</td><td>2</td><td>3</td></tr> <tr><td>1</td><td>2</td><td>3</td></tr> </table>				0	0	1	0	0	1	4	2	3	4	1	2	3	1	2	3	1	2	3
0	0																					
1	0																					
0	1	4																				
2	3	4																				
1	2	3																				
1	2	3																				
1	2	3																				

	CS	1	LA GRANDIÈRE (ex-Ville d'Ys, renamed 01/04/40)																			
<p><i>Bougainville class '44-45</i> Colonial Aviso (Sloop)</p> <p>6 4</p> <table border="1"> <tr><td>0</td><td>1</td></tr> <tr><td>1</td><td>0</td></tr> </table> <p>Sold for BU '59</p> <table border="1"> <tr><td>0</td><td>1</td><td>4</td></tr> <tr><td>2</td><td>3</td><td>4</td></tr> <tr><td>1</td><td>2</td><td>3</td></tr> <tr><td>1</td><td>2</td><td>3</td></tr> <tr><td>1</td><td>2</td><td>3</td></tr> </table>				0	1	1	0	0	1	4	2	3	4	1	2	3	1	2	3	1	2	3
0	1																					
1	0																					
0	1	4																				
2	3	4																				
1	2	3																				
1	2	3																				
1	2	3																				

	MS	1	ÉLAN																			
<p><i>Élan class '39-41 / 45</i> Minesweeping Aviso (Sloop)</p> <p>6 4</p> <table border="1"> <tr><td>0</td><td>0</td></tr> <tr><td>1</td><td>0</td></tr> </table> <p>Interned '41-'44 / BU '58</p> <table border="1"> <tr><td>0</td><td>0</td><td>3</td></tr> <tr><td>1</td><td>2</td><td>3</td></tr> <tr><td>1</td><td>2</td><td>3</td></tr> <tr><td>1</td><td>2</td><td>3</td></tr> <tr><td>1</td><td>2</td><td>3</td></tr> </table>				0	0	1	0	0	0	3	1	2	3	1	2	3	1	2	3	1	2	3
0	0																					
1	0																					
0	0	3																				
1	2	3																				
1	2	3																				
1	2	3																				
1	2	3																				

MS 1 COMMANDANT BORY

Élan class '39-45
Minesweeping Aviso (Sloop)

6 4

0 0

1 0

Sold for BU '53

0 0 3

1 2 3

0

MS 1 COMMANDANT DELAGE

Élan class '39-45
Minesweeping Aviso (Sloop)

6 4

0 0

1 0

Sold for BU '60

0 0 3

1 2 3

0

MS 1 COMMANDANT DUBOC

Élan class '39-41
Minesweeping Aviso (Sloop)

6 4

0 0

1 0

Sold for BU '63

0 0 3

1 2 3

0

MS 1 COMMANDANT DUBOC

Élan class '42-45
Minesweeping Aviso (Sloop)

6 4

0 0

1 0

Sold for BU '63

0 0 3

1 2 3

0

MS 1 COMMANDANT RIVIÈRE

Élan class '39-42
Minesweeping Aviso (Sloop)

6 4

0 0

1 0

Sunk 28/05/43 / BU '46

0 0 3

1 2 3

0

MS 1 LA CAPRICIEUSE

Élan class '40-45
Minesweeping Aviso (Sloop)

6 4

0 0

1 0

Broken Up '64

0 0 3

1 2 3

0

MS 1 LA MOQUEUSE

Élan class '40-41
Minesweeping Aviso (Sloop)

6 4

0 0

1 0

Broken Up '65

0 0 3

1 2 3

0

MS 1 LA MOQUEUSE

Élan class '42-45
Minesweeping Aviso (Sloop)

6 4

0 0

1 0

Broken Up '65

0 0 3

1 2 3

0

MS 1 COMMANDANT DOMINÉ

Élan class '40-41
Minesweeping Aviso (Sloop)

6 4

0 0

1 0

Broken Up '60

0 0 3

1 2 3

0

MS 1 COMMANDANT DOMINÉ

Élan class '42-45
Minesweeping Aviso (Sloop)

6 4

0 0

1 0

Broken Up '60

0 0 3

1 2 3

0

MS 1 L'IMPÉTUEUSE

Élan class '40-42
Minesweeping Aviso (Sloop)

6 4

0 0

1 0

Scuttled 27/11/42 & 07/08/44

0 0 3

1 2 3

0

MS 1 LA CURIEUSE

Élan class '40-42
Minesweeping Aviso (Sloop)

6 4

0 0

1 0

Scuttled 27/11/42 & 08/44

0 0 3

1 2 3

0

	MS	1	LA BATAILLEUSE
<p><i>Élan class '40-'42</i> Minesweeping Aviso (Sloop)</p>			
<p>Scuttled 09/09/43 & 15/04/45</p>			

	MS	1	LA BOUDEUSE
<p><i>Élan class '40-'45</i> Minesweeping Aviso (Sloop)</p>			
<p>Sold for BU '58</p>			

	MS	1	LA GRACIEUSE
<p><i>Élan class '40-'45</i> Minesweeping Aviso (Sloop)</p>			
<p>Sold for BU '58</p>			

	MS	1	CHAMOIS
<p><i>Chamois class '39-'42</i> Minesweeping Aviso (Sloop)</p>			
<p>Scuttled 27/11/42 & 11/43 / BU</p>			

	MS	1	CHEVREUIL
<p><i>Chamois class '39-'45</i> Minesweeping Aviso (Sloop)</p>			
<p>Sold to Tunisia '59</p>			

	MS	1	GAZELLE
<p><i>Chamois class '39-'45</i> Minesweeping Aviso (Sloop)</p>			
<p>Sold for BU '61</p>			

	MS	1	ANNAMITE
<p><i>Chamois class '39-'45</i> Minesweeping Aviso (Sloop)</p>			
<p>Sold to Morocco 01/61 / BU '67</p>			

	FF	1	L'ADVENTURE (ex-Braid / RN)
<p><i>River class '44-'45</i> Frigate</p>			
<p>Broken Up '61-'62</p>			

	FF	1	CROIX DE LORRAINE (ex-Strule / RN)
<p><i>River class '44-'45</i> Frigate</p>			
<p>Broken Up '61-'62</p>			

	FF	1	LA DÉCOUVERTE (ex-Windrush / RN)
<p><i>River class '44-'45</i> Frigate</p>			
<p>Broken Up '61-'62</p>			

	FF	1	L'ESCARMOUCHE (ex-Frome / RN)
<p><i>River class '44-'45</i> Frigate</p>			
<p>Broken Up '61-'62</p>			

	FF	1	LA SURPRISE (ex-Torridge / RN)
<p><i>River class '44-'45</i> Frigate</p>			
<p>Sold to Morocco '64</p>			

	FF	1	TONKINOIS (ex-Moyola / RN)						
<p><i>River class '44-'45</i> Frigate</p> <p>6 4</p> <table border="1"> <tr><td>1</td><td>0</td></tr> <tr><td>2</td><td>0</td></tr> </table>				1	0	2	0		
1	0								
2	0								
<p>Broken Up '61-'62</p> <table border="1"> <tr><td>0</td><td>0</td><td>3</td></tr> <tr><td>1</td><td>2</td><td>3</td></tr> </table>				0	0	3	1	2	3
0	0	3							
1	2	3							

	K	1	ACONIT (ex-Aconite / RN)						
<p><i>Flower class '41-'45</i> Corvette</p> <p>6 4</p> <table border="1"> <tr><td>1</td><td>0</td></tr> <tr><td>2</td><td>0</td></tr> </table>				1	0	2	0		
1	0								
2	0								
<p>Returned to RN '45</p> <table border="1"> <tr><td>0</td><td>0</td><td>3</td></tr> <tr><td>1</td><td>2</td><td>3</td></tr> </table>				0	0	3	1	2	3
0	0	3							
1	2	3							

	K	1	ALYSSE (ex-Alyssum / RN)						
<p><i>Flower class '41-'42</i> Corvette</p> <p>6 4</p> <table border="1"> <tr><td>1</td><td>0</td></tr> <tr><td>2</td><td>0</td></tr> </table>				1	0	2	0		
1	0								
2	0								
<p>Sunk 10/02/42</p> <table border="1"> <tr><td>0</td><td>0</td><td>3</td></tr> <tr><td>1</td><td>2</td><td>3</td></tr> </table>				0	0	3	1	2	3
0	0	3							
1	2	3							

	K	1	COMMANDANT DETROYAT (ex-Coriander / RN)						
<p><i>Flower class '42-'45</i> Corvette</p> <p>6 4</p> <table border="1"> <tr><td>1</td><td>0</td></tr> <tr><td>2</td><td>0</td></tr> </table>				1	0	2	0		
1	0								
2	0								
<p>Returned to RN '45</p> <table border="1"> <tr><td>0</td><td>0</td><td>3</td></tr> <tr><td>1</td><td>2</td><td>3</td></tr> </table>				0	0	3	1	2	3
0	0	3							
1	2	3							

	K	1	COMMANDANT DROGOU (ex-Chrysanthemum / RN)						
<p><i>Flower class '42-'45</i> Corvette</p> <p>6 4</p> <table border="1"> <tr><td>1</td><td>0</td></tr> <tr><td>2</td><td>0</td></tr> </table>				1	0	2	0		
1	0								
2	0								
<p>Returned to RN '45</p> <table border="1"> <tr><td>0</td><td>0</td><td>3</td></tr> <tr><td>1</td><td>2</td><td>3</td></tr> </table>				0	0	3	1	2	3
0	0	3							
1	2	3							

	K	1	RENONCULE (ex-Ranunculus / RN)						
<p><i>Flower class '41-'45</i> Corvette</p> <p>6 4</p> <table border="1"> <tr><td>1</td><td>0</td></tr> <tr><td>2</td><td>0</td></tr> </table>				1	0	2	0		
1	0								
2	0								
<p>Returned to RN '45</p> <table border="1"> <tr><td>0</td><td>0</td><td>3</td></tr> <tr><td>1</td><td>2</td><td>3</td></tr> </table>				0	0	3	1	2	3
0	0	3							
1	2	3							

	K	1	ROSELYS (ex-Sundew / RN)						
<p><i>Flower class '41-'45</i> Corvette</p> <p>6 4</p> <table border="1"> <tr><td>1</td><td>0</td></tr> <tr><td>2</td><td>0</td></tr> </table>				1	0	2	0		
1	0								
2	0								
<p>Returned to RN '45</p> <table border="1"> <tr><td>0</td><td>0</td><td>3</td></tr> <tr><td>1</td><td>2</td><td>3</td></tr> </table>				0	0	3	1	2	3
0	0	3							
1	2	3							

	K	1	LOBELIA (ex-Lobelia / RN)						
<p><i>Flower class '41-'45</i> Corvette</p> <p>6 4</p> <table border="1"> <tr><td>1</td><td>0</td></tr> <tr><td>2</td><td>0</td></tr> </table>				1	0	2	0		
1	0								
2	0								
<p>Returned to RN '45</p> <table border="1"> <tr><td>0</td><td>0</td><td>3</td></tr> <tr><td>1</td><td>2</td><td>3</td></tr> </table>				0	0	3	1	2	3
0	0	3							
1	2	3							

	K	1	MIMOSA (ex-Mimosa / RN)						
<p><i>Flower class '42</i> Corvette</p> <p>6 4</p> <table border="1"> <tr><td>1</td><td>0</td></tr> <tr><td>2</td><td>0</td></tr> </table>				1	0	2	0		
1	0								
2	0								
<p>Sunk 09/06/42</p> <table border="1"> <tr><td>0</td><td>0</td><td>3</td></tr> <tr><td>1</td><td>2</td><td>3</td></tr> </table>				0	0	3	1	2	3
0	0	3							
1	2	3							



M Small Cargo Ship

6 4

0 0



0



M Large Cargo Ship

6 4

0 0



0



M Transport

6 4

0 0



0



M Troopship

6 4

1 0



0

M Auxiliary Ship

9 6

0 0



0

Airstrip

0

10 5

CT

READY AIRCRAFT

UNREADY AIRCRAFT

35

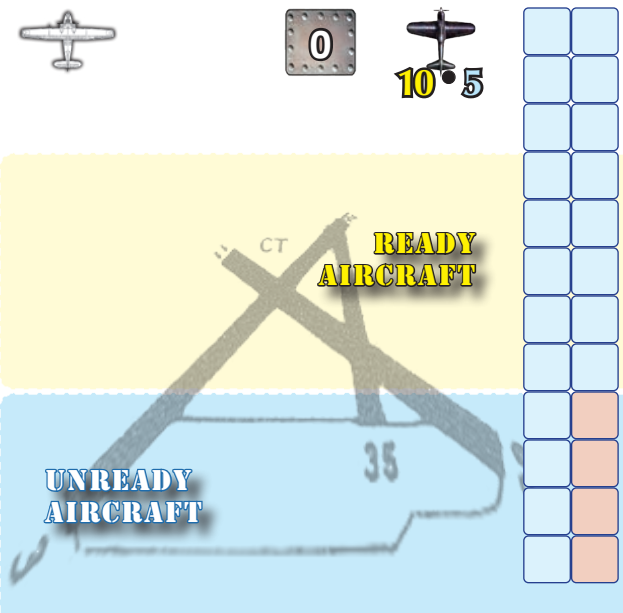

Airfield

0

16 8

CT

READY AIRCRAFT

UNREADY AIRCRAFT

35

