

Army Maker non-European Powers v1

For Lasalle Second Edition



Lasalle Second Edition is copyright 2021 by Sam Mustafa Publishing LLC.
All text and images used with permission.

By David F Brown

Introduction

These lists cover powers outside the western European theatre of the Napoleonic wars. Non-European troops often fought, were armed or were organised in ways that do not directly equate to standard European troops of the age. Therefore some additional Traits and associated rules are presented to bring out the nature of such armies.

Some of the traits may also be useful for Europeans pre-1805 and for those of less well organised forces such as massed 'irregulars' of some conflicts.

A few lists have a greater variety of troops than European forces. This is perhaps understandable as the armies were by their nature less constrained by official training codes or contained troops fighting in a distinct traditional tribal or ethnic style; however attempts have been made to not unnecessarily create differences where possible. Many armies underwent 'Europeanisation' of their military and will thus contain troops reflecting two different cultures.

The Traits and troops here should probably be used only as options within the framework of the Advanced sections of the *Lasalle Second Edition* rules.

No nations have been listed as clients. Partly this reflects the larger geography, also that small semi-independent polities are already assumed to be present within the usual structure of feudal style armies, but mostly the rules covering them just don't seem to fit the nations presented here. Some states are listed as a Minor Power which here is simply a guide to relative size and capacity.

The dates listed for 'At War' and who might be treated as allies is more fluid, in the first case because many nations would not make formal declarations of war or formally renounce treaties and feudal potentates might become allies to foreign powers without the knowledge of approval of their ruler.

The suggested date range of armies may extend beyond the usual notions of 'Napoleonic', this is included for general information and because the mechanisms of the rules remain appropriate for the broader time span.

In compiling these lists I've taken a dive into primary sources and academic research work as far as time has reasonably allowed. However I make no claims to being an authority on the armies (except maybe the Persians), many will be new to some wargamers, it seems certain I will have missed some important data or blundered an interpretation.

I'll update and add armies in between painting figures and rolling dice.

Armies Included:

Persia - Qajar Dynasty	p5	Ali of Egypt	
Wahhabist Arabs	p8	Sikhs	
Omani	p10	India - Moghul Dynasty, Successors	
Afghanistan - Durrani Empire	p13	Marathas, Gurkhas	
- Jihad of Soofee Islam		Hyderabad	
Khanate of Khiva	p16	Mysore	
Emirate of Bokhara	p17	Travancore	
Khanate of Kokhand	p18	Nairs	
Kazakh Hordes	p19	Amirs of Sind	
- Kirghiz or other Steppe Clans		East India Company	
Turkmenia	p20	Nepal	
Kalat Khanate	p21	Burma	
Tribal or Gulf-state Arabs	p23	Manipur	
Georgia - Bagratid Dynasty	p25	Thailand	
- Imereti, Mingrelia, Svaneti,		Qing Dynasty Chinese	p55
- Guria, Abkhazia		- Chinese Rebels	
Cossack Invasion of India	p28	Sri Lanka	
Avar Khanate, Caucasus Khanates,		Indonesian French	
Kurd Emirates	p29	Indonesian	
French Army of the Orient	p31		
British in Egypt	p34		
Mamluk	p37	Armies in magenta to come in a future update.	
- Mamluk - Meccan Alliance			
Georgian Mamluk Baghdad	p40		
Sultinate of Sinnar	p43		
Shayqya Confederacy	p45		
Shilluk Kingdom	p46		
- Dinka, Nuer			
Darfur	p47		
- Kordofan, Wadai, West Africa			
Ali Pasha Lion of Ioannina	p49		
Tripoli, Tunisia, Algeria	p52		

Suggested Traits for Non-European troops, and perhaps others before c.1805

 = **Zamburak**, Artillery. These are the camel-gunners of Asian and African armies where the men shoot while atop the beast. Bombard maximum range is 10BW with **no bounce** to harm secondary targets.

Move rate as Cavalry in Mass. These can form Mass (two bases wide) or March (two deep). They can not and do not need to 'unlimber' and can shoot while in either formation but only with front-rank bases, therefore half dice if in March. For anything not mentioned count as **Horse Artillery** mostly with a **+5 To Hit number**. They shoot with two (2) dice.

Cost is computed as Firepower base cost of 7, (derived from the open architecture) +2 for Horse Art, -2 for the poor To Hit #, -1 for no bounce through, -1 for short range, +1 for no unlimbering = 6 points.

 = **Melee Only** Infantry, these troops have no or very few fire-arms and thus **do not shoot**. Their skirmish value represents a minority with firearms or other friendly troops operating near them.

Melee Only troops **do not pay** the IMO complication for charging, if in Mass. These count difficult terrain and interpenetration Complications in the same way that others do.

Melee Only, if charging, re-roll combat dice scores of 1 vs Infantry. The re-rolled dice determine any Upset Victory.

Cost is -2 points per unit. There is no particular derivation for the cost other than losing shooting is half the capacity to harm the enemy and the benefits of charging and combat are considered a modest recompense.

 = **Camel Mounted Infantry** such troops move in March formation at Cavalry distance and count such moves through soft sand (treat as Rocky Ground Difficult) as Open terrain. Many camel-riders were 'mounted infantry' rather than expected to fight from the mount. Such beasts were often used to increase the general strategic speed of an army and this trait should be used only where the mounts are kept close by and used as a tactical expediency.

 = **Horse Mounted Infantry** as above but without sand-traversing capacity.

For both types of Mounted Infantry the troops can Disengage as Foot, or **Disengage a full Infantry move, but with a Complication** if enemy Cavalry is within 4BW. The troops remain as Foot for anything not mentioned.

Cost is +1 point per unit for either kind of Mounted Infantry.

 = **Pikemen** representing Infantry fighting with long spears. These **do not shoot**. Their skirmish value represents a minority with firearms or other friendly troops operating near them.

Pikemen troops **do not pay** the IMO complication for charging, regardless of their present formation.

Pikemen count as if in Square when charged by Cavalry except; if the Pikemen are in March formation or if *any* enemy has contacted their flank or rear. Unless otherwise noted they can still form Square - and take all the usual benefits and penalties for so doing.

Cavalry **Lancers gain no re-roll** benefit against Pikemen.

Any move by Pikemen in **Line formation** is a Complication, any **Formation Change** by Pikemen is a Complication.

Cost is -2 per unit. There is no particular derivation for the cost other than losing shooting is half the options for harming the enemy and the combat benefits are a modest recompense for this and the additional Complications.

The Pike, Part-pike and Melee Only Traits are mutually exclusive, troops can have only one of these.



= Part-Pikemen. For Infantry armed with a mix of pikes / spears and some men with firearms. These count all the qualities of Pikemen but **can shoot** with the following penalty; **they shoot shifted down ie hit on 5+**.

Cost = +1 point per unit, the benefits and disbenefits are held to largely cancel out.



= **Elephants**. Some Indian and South-east Asian nations fielded war elephants. They appear to have used them mostly in the same way as other four-leg mounts. Those units with only an officer or two mounted on elephants leading massed horsemen, are treated just as the horsemen, however a model elephant or two can be included on the bases for visual interest. Artillery drawn by elephants are considered the same as other limbers. Asian army markers or icons should include as many pachyderms as possible.

European writers believed the increasing improvement in artillery caused the decreasing use of war elephants.

Elephants is a Trait for Cavalry. **Elephants** count as the Trait of Shock - but only if charging or in combat with Cavalry. Non-Elephant Cavalry **do not count as Shock** if charging against Elephants or if in combat with them.

Artillery shooting at Elephants **shift up** their roll to hit them (Rockets don't shift twice). Elephants **Rally** is never shifted up to 3+ for any reason.

Most Elephants had a crew or runners armed with firearms or light guns - Elephants **can volley shoot** as if Infantry, but with **Weak Fire** (ie 1 dice per front rank base) and a basic **to hit score of +6**.

Cost = +2 per unit, many of the benefits and disbenefits are held to cancel out.



= **Bows**, a Trait for Infantry. For troops armed with non-firearm missile weapons, or with only a handful of firearms mixed with other weapons. Bows are **shifted down when shooting to hit, ie they hit on 5+**.

Cost = -2 per unit. (Derived from the Artillery example in the open architecture). Those Part-pike troops depicted with non-fire-arms do not take a double shooting penalty and don't acquire the Bows Trait.



= **Rocketeers**, a Trait for Artillery. Asian rocketeers equipped with riding and pack camels or horses can be classed exactly as the British troop in the main rules / lists, excepting there can be more than one of them per army.

Massed footmen rocketeers of Asian armies presumably had stores of rockets nearby and Limbering / Unlimbering can represent readying them for use. Classifying them as the Rocket example in the rules is not a bad fit and avoids the need to create further exceptions. The multi-slot rocket launching devices of Mysore are such a mystery that no additional rules are suggested for them.



= **Jingal**, a Trait for Artillery representing light man-portable weapons in the form of very small guns or giant 3-4-5 crew muskets, perhaps with the weapons on stands.

Even if lacking pack animals these must be in a nominal 'Limbered' or 'Unlimbered' formation to show preparedness for shooting. They **move as Infantry in Line** if '**Unlimbered**' and **Infantry in March** if '**Limbered**' and count terrain as if Infantry, they can thus move through and fire from Difficult terrain. Being in Water terrain stops their shooting as for all other troops.

Bombard **maximum range is 10BW** with **no bounce** to harm secondary targets, **+5 To Hit number**, and (2) two dice. For anything else not mentioned count as **Foot Artillery**.

Cost is computed as the same as Zamburaks = 6 points.

Small or Weak Batteries - for guns present in smaller than usual numbers for a company, a two-base unit is still used but they have only (2) **two-dice** firepower. Some two-dice artillery in the lists represent the usual number of tubes but with antiquated weapons and ammunition or significantly incompetent crews.

The 7 point cost for two firepower dice is derived from the points progression in the open architecture section.

Sharpshooters

Melee Only, **Pikemen** and **Part Pikemen** may not be deployed as Sharpshooters.

Cavalry with a **better than 1 skirmish** factor are those practised at shooting dismounted, perhaps from localised cover, with long-barrel weapons.

The cost is +2 per unit with a Skirmisher value of 2.

Brigade Structure

Some of the armies presented here have a note that a brigade can not be assembled from Army Assets - these must instead be distributed to the other brigades as described. Items that are less typical for the nation have sometimes been made reserves.

Army Notes

Most armies have a potted history or some trivia included with their list. This information might include detail on uniforms, weapons or organisation of the less well known forces.

Limited Numbers

Some troop types are listed with a maximum number (0-1) or (0-4) etc, this is the total maximum of that type of unit able to be fielded in the army, either via Army Assets or Brigade composition.

Feudal Doctrine Armies

Some non-European armies may qualify as Linear Doctrine. Many others could be 'Feudal Doctrine'.

Infantry and Artillery of **Feudal Doctrine** armies count a **complication** for Formation Changes.

A Feudal Doctrine army can **as their Intervention** choose to perform the **special function** of 'Give Way'.

In a 'Give Way' units within 4BW of the general marker can immediately make a move, of Reduced length, but such a move must be made to **increase the separation** from enemy and not come within 4BW of any enemy. It does not count as their move for the turn.

David F Brown, February 2021.

Trait Points Summary

 **Zamburak**, 6 points per unit.

 **Melee Only**, -2 points per unit.

 **Camel Mounted Infantry**, +1 point per unit.

 **Horse Mounted Infantry**, +1 point per unit.

 **Pikemen**, -2 points per unit.

 **Part Pikemen**, +1 point per unit.

 **Elephants**, +2 points per unit.

 **Bows**, -2 points per unit.

 **Rocketeers**, 5 points per unit.

 **Jingals**, 6 points per unit.

Weak Battery, 7 points per unit.

Cavalry SK2, +2 points per unit.

Historical Parameters

At War: 1779+, 1804-15.

Allies: Turkey 1809-11, Caucasus Khanates 1779+, Turkmenia 1779+.
(See also the Omani list.)

Enemies: Russia 1804-13, Turkey 1805-06, Wahhabist Arabs 1802-1812, Afghanistan (1779+) 1805-15, Bukhara 1785, 1814+, Turkmenia 1779+, civil wars 1779+, Caucasus Khanates 1779+, Georgia 1795-1801.

This list covers the Qajar dynasty of Persia (Iran) with the starting date representing the end of the preceding Zand dynasty. The army list can be extended into the 1820s, at least, to cover the wars with Turkey and Russia during that decade.

The nation underwent a modernisation and adoption of European methods and uniforms from 1807, at first with Russian freelance advisors and then a formal French mission which was replaced by the British mission of 1810.

Napoleon tried to get Persia and Turkey to attack Russia as a distraction for his 1812 campaign.

Sarbaz were the new regular uniformed infantry battalions, they were sometimes officered by Europeans. The Qajar modern horse artillery (often with British commanders) were noted as excellent troops, even by their Russian enemies. Sarbaz could vary from good quality to woeful, some 'militia' units were noted as not yet being fully trained in the new methods.

The Army has an option for **Feudal Doctrine** up to 1806. Brigade structures were formalised only in the 19th century beyond the period of the rules. Battle reports describe particular troops grouped and fighting near each other which party inspires the brigades above. Tribal troops were often kept together as ethnic groups to avoid mischief between them.

Horse Artillery and '+4 to hit' Foot Artillery are uniformed troops as are the Shah's Guard Zamburaks, other artillery can be either uniformed or traditional.

Ghulams were the elite cavalry. They were permanent troops armed, clad and paid by the state, in the 1820s and perhaps earlier they were uniformed. Joushan-pushan were armoured lancers.

Nizam-Atli were uniformed lancers, they were described as woeful by every European observer and despised by locals as a pointless concept.

The Bagaderan '*heroes*' were the elite 'foreign legion' of Russian deserters with a fearsome reputation - they were at times described as a 'guard' formation along with a similar-status unit of locals.

Keshikichis were a household unit within the pre-European standing infantry. Jazairchis and Shamhkalchis used long-barrel weapons on a bi-pod - they could be uniformed or traditional.

No army can have more than one unit of Gholam-toffangchi.

Persia - Army Tablet

Major Power

Cavalry	Infantry	Artillery
Gholam-shah  20  6 5 4 3 2 1 	Sarbaz  16  6 5 4 3 2 1 	Heavy Artillery  10/12 2 1   4+ or 5+  
Provincial Cavalry  15 6 5 4 3 2 1 	Raw Sarbaz, Uniformed Toffungchi  9  6 5 4 3 2 1 	Light Artillery  8 2 1   5+ 
Joushan-pushan  16  5 4 3 2 1 	Bagaderan (0-1)  20  6 5 4 3 2 1 	Horse Artillery  12 2 1   4+  
Tribal or Militia Cavalry  11  5 4 3 2 1 	Janbaz or Keshikshis  12  6 5 4 3 2 1 	Foot Artillery  12 2 1    4+ 
Nizam-atli  11  5 4 3 2 1 	Elajauree or Levy  6  5 4 3 2 1 	Zamburaks  6 2 1   5+  
Gholam-toffangchi (0-1)  19  6 5 4 3 2 1 	Tribal or Militia Infantry  9  5 4 3 2 1 	Shah's Guard Zamburaks (0-1)  8 2 1   4+  
	Jazairchis or Shamhkalchis  12  5 4 3 2 1 	Swivel Guns  6 2 1   5+  



Notes, 0-2 Militia Infantry or Jazairichi can be **Horse Mounted Infantry** at +1 point each.



0-1 Tribal Infantry or Levy, up to 1810, can be armed with Bows at -2 points.

The '+5 to hit' artillery are pre-European non-uniformed guns or light swivel-style guns.

Tribal - Militia Cavalry Bde

2-6 Tribal or Militia Cavalry
 0-1 Provincial Cavalry
 0-1 Zamburak



Royal Cavalry Bde

1

1-2 Gholam-Shah
 0-1 Gholam-Toffunchi
 0-1 Guard Zamburak (1807+)

Army Assets

0-1 Zamburak
 0-1 Horse Artillery (1807+)

0-1 Heavy Artillery
 0-1 Light Artillery
 0-1 Bagaderan
 0-1 Nizam-Atli (1807+)
 0-1 Gholam-Toffungchi
 0-1 Jazairichi or Shamkhalchi

0-1 Sapper

0-6 Partizans

Note - a brigade can not be assembled from army assets, they may only be distributed to other brigades.

Note - the Nizam-Atli can be attached only to a Cavalry Brigade or Regular Infantry Brigade.

Infantry assets can not be attached to any type of Cavalry Brigade.

Cavalry Bde

2

0-1 Gholam-Shah or Provincial Cavalry
 1-3 Joshan-pushan
 1-3 Tribal or Militia Cavalry
 0-1 Zamburak or, if 1807+ Horse Artillery

Janbaz Bde

1

2-4 Janbaz, Keshikchi or if 1807+ 'Uniformed' Toffungchi
 0-1 Light Artillery

Tribal - Militia Infantry Bde

3-6 Tribal or Militia Infantry
 0-1 Janbaz
 0-1 Zamburak or Swivel Gun

1

Eeljauree or Levy Bde

3-6 Eeljauree or Levy

Regular Infantry Bde (1807+)

2

2-4 Sarbaz (any)
 1-3 Tribal or Militia Infantry
 0-1 Zamburak, Foot Artillery or Horse Artillery



Note: The Tribal - Militia Cavalry Brigade is **essential** only to 1806. From 1807 the Regular Infantry Brigade is **essential**.

1

Historical Parameters

At War: 1780s - 1818.

Allies: Tribal or Gulf-state Arabs 1790s+.

Enemies: Ottomans 1802+, Egypt 1806-18, Omani 1802+, Persia 1783+, 1802-1812, Tribal Arabs 1790s+, British 1790+ (French in Egypt 1800-01*).

This list covers the Wahhabist Arab armies inspired by their bracing form of Islam. Their exploits at capturing and looting cities (holy or otherwise) stunned the Islamic world. Some tribes joining their forces were more inspired by bribes or the prospect of loot than religious purity.

Some Wahhabist generals were canny tacticians understanding the relative strengths of their forces and their more organised enemies, while others fell to ruses such as a famous feigned-flight by Ottoman cavalry.

Warriors with strength seven and the Resilient Trait is to reflect fanaticism such as gathering and throwing back live artillery shells or groups of men tying their legs together to make retreat impossible.

The *mendjyeh* bodyguard lancers were fearsome volunteers who asked for and gave no quarter in battle - the men and horses wore quilted armour.

The army was always short of firearms. Artillery was also scarce and gained by capturing Ottoman or other guns. European travellers suggest the general 'warrior' infantry had only one man in ten with a firearm.

Armies were raised by a levy (often by lot) of men aged 16-60 and refusing the call-up met with predictably dire outcomes. The state would provide riding beasts for those lacking them, gunpowder and sometimes supplies. The cavalry was considered the equal or better of Egyptian Mamluks. Cavalry could be levied separately from infantry which had the perverse effect of men selling horses to avoid the over-frequent call-up of these.

Some Ottoman garrisons joined the Wahhabists. City defenders can include women helping the fighters. Field armies were not recorded with artillery - which if included must be assumed to have come from a close nearby city.

Camel trains supporting a raiding army might contain bulk quantities of salt which was used to foul wells and hamper a pursuing enemy. Some reports described men riding two per camel and a contemporary but not eye-witness British account has them fighting from the beast and armed with muskets. The rear rider faced the rear.

Armies should include plenty of flags including green for any descendants of Ali. Jihadists wearing distinctive green turbans answered the call to combat the French in Egypt, the other troops crossing the Red Sea were 'government' troops from the Sharif of Mecca who had a financial motive to restore trade and pilgrimages to the holy cities. Listing the French* as a possible enemy here is a 'what if' that assumes larger and different forces from Arabia could have been inspired to campaign in Egypt (see also the Mamluk sub-list).

The 1818 end date is the defeat suffered at the hands of the reformed Ottoman-Egyptian armies of Ali.

Wahhabist Arab - Army Tablet

Major Power

Cavalry	Infantry	Artillery
Mendjyeh Guard (0-1) 22 6 5 4 3 2 1 5+	Warriors 11 1 7 6 5 4 3 2 1 3+	City Artillery 5 2 1 5+ 6
Cavalry 18 6 5 4 3 2 1 5+	Mercenary or Yemeni Matchlock-men 13 2 6 5 4 3 2 1 4+	Note: any non City Levy infantry can be made Camel Mounted Infantry , at +1 point each.
Tribal or Subject Arab Cavalry or Camel rider 12 1 5 4 3 2 1 3+	Arab or Negro Guards 13 1 6 5 4 3 2 1 5+	
City Levy, Tribal or Subject Arabs 6 1 5 4 3 2 1 3+	Garrison or Ottomans 7 2 5 4 3 2 1 3+	

Wahhabist Arab - Brigade List

Major Power

Warrior Bde 3-6 Warrior 0-1 Garrison or Ottomans	Garrison Bde 1 1-2 Garrison or Ottomans 0-1 City Artillery	Army Assets 0-1 Mendjyeh Guard 0-2 Arab or Negro Guards 0-2 Mercenary or Yemeni Matchlock-men 0-3 Partizans Note - a single brigade of two (2) units can be assembled from army assets, others may only be distributed to non-tribal / subject brigades.
Cavalry Bde (to 1811) 2-3 'Cavalry'	Tribal or Subject Arab Bde 2 1-2 Tribal or Subject Arab Cavalry or Camel riders 0-3 Tribal or Subject Arab Infantry	
1 Cavalry Bde (1812+) 2-3 'Cavalry'		
1 City Levy Bde 3-6 City Levy Infantry 0-1 City Artillery		
		2

Historical Parameters**At War:** 1790s - 1815+.**Allies:** Tribal or Gulf-state Arabs 1790s+, Persia 1811-12, Britain 1808+.**Enemies:** Tribal or Gulf-state Arabs 1790s+, Wahhabist Arabs 1805-1809, Persia 1799, Kalat Khanate 1790s+.

This list covers the Omani state on the Persian Gulf; while primarily a naval and trading nation their forces were involved in various conflicts. The British maintained an alliance with Oman to both protect regional trade and ensure other powers did not use them as a springboard to attack British interests in India.

The Wahhabist cavalry was stationed in Muskat when the state was subject to the Wahhabists. It was described as the sultan's bodyguard and was presumably tasked to also ensure he behaved without independence.

Cavalry lancers are mentioned when fighting the Wahhabists. 'Europeanised' cavalry were armed with British sabres, carbines and modern pistols.

Many actions included close support from the extensive Omani fleets which could transport significant landing forces. Marine pike-men include examples such as one ship's complement of 1000 armed with 'lances'.

Wild Desert Arab infantry were armed with sword or spear and shields, they wore only a blue loincloth. The Baluchi infantry were described as veteran or guard troops.

The Persian component of the allied army that faced the Wahhabists is best represented by the brigade shown here as it included an atypical mix of troops and items not seen elsewhere in Qajar armies. Use the Persian army tablet for such troops.

Omani possessions in East Africa, especially at Zanzibar, could field troops broadly like the infantry of this list. However forces there before the 1820-30s appear too small and lack an organised opposition to deserve separate consideration.

Oman - Army Tablet

Minor Power

Cavalry

Infantry

Artillery

Arab or Baluchi
Cavalry



6 5 4 3 2 1



City Omani, Baluchi
or Sindian Infantry



5 4 3 2 1



Artillery



2 1



5+



Europeanised Cavalry
(1811+)



6 5 4 3 2 1



Baluchi or Sindian
Guard Matchlock-men



6 5 4 3 2 1



Detached Ships or
other Guns



2 1



4+



Bedouin, Omani or Arab
Cavalry or Camel riders



5 4 3 2 1



Wild Desert Arabs



5 4 3 2 1



Note: 0-6 non-allied infantry
can be made **Camel Mounted
Infantry**, at +1 point each.

Garrison or Marine
Matchlock-men



5 4 3 2 1



Marine Pike-men



5 4 3 2 1



British - Indian
'Sipahis' - Sepoys



6 5 4 3 2 1



2

Infantry Bde

- 1-3 City Omani etc Infantry
- 0-1 Garrison Matchlock-men
- 0-1 Wild Desert Arab Infantry
- 0-1 Baluchi Guard Matchlock-men ★

2

Marine Bde

- 1-3 Marine (any)

Army Assets

- 0-1 Wahhabist 'Cavalry' from that list (1806-09)
- 0-2 Artillery (any)
- 0-2 Baluchi or Sindian Guard Matchlock-men
- 0-2 Arab, Baluchi or Europeanised Cavalry

Note - Artillery can be distributed to a British Allied brigade otherwise they are limited to non-allied and non 'Bedouin or Other' Arab brigades.

2

1

Persian Allied Bde (1811-12)

- 0-1 Provincial Cavalry
- 1-2 Provincial Cavalry, Tribal or Militia Cavalry or Joushan-pushan
- 1-2 Zamburak
- 0-1 Light Artillery (with Russian gunners)

1

Bedouin or other Arab Bde

- 1-2 Bedouin or other Arab Cavalry or Camel Riders
- 1-3 Wild Desert Arab Infantry

1

British Allied Bde (1808+)

- 2-3 Foot Regiment (Veteran)
- 0-2 'Native Sipahis' - Sepoys

Note: the Persian and British are not Reserve Brigades, they are coloured to show troops of a different origin.

British and Persian Allies can not be used together or either with Wahhabist cavalry, unless you want a 'what-if' scenario. The Persian force contained unusual troops and in a mix that needs its own brigade structure. The Zamburaks were two-gun items, it is uncertain if this meant two gunners per beast (as seen in some Indian sub-continental examples) or a camel mounted with a gun at each end and only one gunner. The Light Artillery were manned by Russian deserters - the only record of such a unit in Persian service.

The Persian-Omani allied force defeated the Wahhabists in one battle but were destroyed in a second encounter.

British forces helped their Omani ally fight Gulf-state / Wahhabists and 'Jossamy pirate' cities. The British troops were regular infantry regiments and possibly marines which are here counted the same. One force included 'native sipahis'.

The British helped organise more modern and mobile artillery for the Omanis, however some of these were mortars or detached ships guns for reducing cities. One British force included Bombay artillery. *Sipahi* means 'army, soldier' in Farsi - Urdu (and Turkic?) and when not applied to cavalry, some Europeans used it for irregular skirmishing infantry. Sipahi also translates to sepoy. In the late 1700s to early 1800s it was used interchangeably (if rarely) with sepoy for some British forces in India.

In 1818 and into the 1820s British allies provided more numerous forces including Indian Native Infantry and a larger artillery component, these should be represented by a different and larger allied contingent.

Historical Parameters

At War: 1770s+.

Allies: Bukhara 1788-89, 1793, Khalat Khanate 1770s+.

Enemies: Persia, Sikhs 1795, 1797-98, 1811+, civil wars, Ghiljie tribes 1801-2, Moguls and Successors 1770s+

This list covers the Durrani Empire of Afghanistan as founded by Ahmad Durrani Shah (r 1747-1772), who was a general of Nadir Shah. The state expanded into eastern Iran, modern Afghanistan, parts of India, Pakistan and Turkmenistan. The Afghans faced continual threats from the Persians attempting to retake western regions and from the rising Sikh state in particular.

Rulers in Afghanistan had to manage a bewildering array of tribal and clan loyalties. Treachery, coups, murder and civil war were never far off. The qizzilbash were the ethnic Persians as descendants of Nadir Shah's troopers, they and other foreigners were the Ghulam soldiers noted for mistreating the local lower classes. Tribal troops can be ethnic Pashtuns Hazzara, Eimaks, Beluchi, Tajik, Tartar, Uzbek and others.

Some potentates rode elephants in parades but probably not in battle. The dangerous master schemer Futteh Khan wore all black at the battle of Kahreeze / Kafer-Qal'a (problematically dated in European sources 1816-17-18) where a massed cavalry charge almost swept the Persian enemy from the field before these re-grouped to score a victory. The battle saw Futteh Khan wounded in the mouth, in one account by a coin, bags of which were used by the Persians as makeshift canister when other ammunition ran out.

Afghan cavalry was noted for its quality and numbers. The infantry and artillery underwent a slow process of Europeanisation under influence from British India during the 19th Century.

A sub-list caters for the uprising of Soofee Islam, a charismatic religious leader, who inspired masses, some 'government' soldiers and Eimaik tribesmen into a doomed war. Such an army should include Islamic clerics as markers, icons or on the bases. Soofi Islam went into battle carried on some form of palanquin. He and his fanatic but ill-disciplined forces were destroyed near Herat by the Qajar general Mohammad Khan Davallu.

Afghans can optionally use **Feudal Doctrine**.

Afghanistan - Army Tablet



Major Power

Cavalry

Infantry

Artillery





Guard Qizzilbash or Peshkedmuts  **21**

6	5	4	3	2	1
---	---	---	---	---	---

 **3+**

Ghazis or Religious Mob  **9**

 **1**   

6	5	4	3	2	1
---	---	---	---	---	---



 **3+**

Light Artillery  **5**

2	1
---	---

  **5+**  **6**





Qizzilbash or other Ghulams  **19**

6	5	4	3	2	1
---	---	---	---	---	---

 **4+**

Mountain Tribe  **10**





 **2**   

5	4	3	2	1
---	---	---	---	---



 **4+**

Zamburaks  **6**

2	1
---	---

  **5+**   **6**



Feudal Cavalry  **16**

 **1** 

5	4	3	2	1
---	---	---	---	---

 **5+**

Sepoy  **9**

 **1** 

6	5	4	3	2	1
---	---	---	---	---	---

 **3+**



Tribal, Nomad or Karra Nokur Levy Cavalry  **11**



5	4	3	2	1
---	---	---	---	---

 **3+**



Karra Nokur, Eeljauree or Dawaltullub Levies  **6**

 **1**  

5	4	3	2	1
---	---	---	---	---

 **3+**

Oolloossee Levy  **5**

 **1**  

5	4	3	2	1
---	---	---	---	---

 **3+**

Afghanistan - Brigade List

Major Power

Elite Cavalry Bde
2 2-3 Qizzilbash or other Ghulam
 0-3 Tribal or Subject Arab Infantry

Ghazi or Religious Mob Bde
2 2-5 Ghazi or Religious Mob

Army Assets
 0-1 Guard Qizzilbash or Peshkedmut Cavalry
 0-2 Zambuark
 0-1 Light Artillery
 0-1 Sepoy (1808+)
 0-1 Karra Nokur Levy Cavalry
0-6 Partizans
1

Tribal or Nomad Bde
 2-5 Tribal or Nomad Cavalry

Eeljauree, Karra Nokur Levy or Dawaltullub Bde
1 2-5 Eeljauree, Karra Nokur Levy or Dawaltullub

Feudal Cavalry Bde
 0-1 Qizzilbash (any) or other Ghulam
 2-4 Feudal Cavalry
 0-1 Tribal Cavalry 

Oolloossee Bde
1 2-5 Oolloossee

Mountain Bde
1 1-3 Mountain Tribe

Afghan Brigade List - Jihad of Soofee Islam 1805/07

Feudal Cavalry Bde
1 0-1 Other Ghulam
 0-1 Feudal Cavalry
 1-2 Tribal Cavalry

Religious Mob Bde
 3-5 Religious Mob 

Army Assets
 0-1 Light Artillery
1



Eeljauree or Dawaltullub Bde
1 3-5 Eeljauree or Dawaltullub

Tribal or Nomad Bde
1 2-3 Tribal or Nomad Cavalry

Note - this sub-list can use no allies and is limited to the troops shown here.

Khanate of Khiva

Minor Power

Cavalry	Infantry	Artillery
Khan's Guard (0-2)  21  ← 6 5 4 3 2 1 	City Defenders  6  1   5 4 3 2 1 	Light Artillery  5 2 1   5+ 
Cavalry  16  1 6 5 4 3 2 1 	Historical Parameters At War: 1804+. Allies: Rebel Persian Nobles and / or Turkomen, 1814-18. Enemies: Bukhara 1805+, 1810-13, Persia, 1814+.	Swivel Gun  6 2 1   J 5+ 
Nuker Levy Cavalry  11  1 5 4 3 2 1 		Notes: Up to 1 in 5 'Cavalry' units can have Lance for +1 point per unit. City defenders can be <i>all or none</i> as Melee Only rather than Weak Fire (also costing 6 points).

Khanate of Khiva - Brigade List

Minor Power

Khan's Bde 1 1-2 Khan's Guard 0-2 'Cavalry'	Cavalry Bde  2-5 'Cavalry'	Army Assets 0-1 Light Artillery or Swivel Gun 0-1 Khan's Guard 0-6 Partizans 1
City Defender Bde 1 1-2 City Defender	Nuker Levy Bde 2-6 Nuker Levy Cavalry	

This list covers the Uzbek-majority Khanate of Khiva (or Khwaizm Khanate) in Central Asia. The 1804 start date is an approximation for more orderly times following a period of anarchy from the mid 18th century.

Some cavalry wore armour. Long-barrel bi-pod muskets gradually replaced bows as a missile weapon for dismounted use during the 18th Century.

Light artillery can be any motley mix of captured items, jingal-like swivel guns or a multi-barrel contraption on a cart. Gunners could be a mix of Russian, Persian, Afghan or other foreigners.





































Khivans were noted for their tall broad-topped sheepskin hats and long coats of coloured vertical stripes in blue, red or grey.

Europeanised infantry were raised from the 1850s, and then only in small numbers.

The Army can optionally be of **Feudal Doctrine**.

Khanate of Khokand

Minor Power

Cavalry	Infantry	Artillery	
Khan's Guard (0-2)  21  ← 6 5 4 3 2 1 	City Defenders  6  1   5 4 3 2 1 	City Artillery  5 2 1   5+ 	
Sipahi / Feudal Cavalry or Afghans  16 ← 6 5 4 3 2 1 	City Bowmen (0-2)  4  1    5 4 3 2 1 	Zamburaks  6 2 1   5+  	
Provincial Sipahi or Militia Cavalry  14  1 ← 5 4 3 2 1 	Historical Parameters At War: 1801+ Allies: Khazaks, Kirgiz. Enemies: Bokhara, Chinese - Kirgiz - Turkestan 1810+, Khazaks, Afghans, Russia.	Jurks - Jingal  5 2 1   5+  	
Tribal or Nomad Cavalry  11  1 5 4 3 2 1 			

Khanate of Khokand - Brigade List

Minor Power









1 Khan's Bde 1-2 Khan's Guard 1-3 Sipahi (any)	Cavalry Bde  1-2 Sipahi / Feudal Cavalry 1-3 Provincial Sipahi / Militia or Tribal Cavalry	Army Assets 0-1 Zamburak 0-6 Partizans
1 City Bde 3-5 City infantry (any) 0-1 Artillery (any)	2 Tribal or Nomad Bde 2-4 Tribal or Nomad Cavalry	1

This list covers the Uzbeks of Khokand who became independent of Bokhara from the mid 1700s. The 1801 start date is an estimate for the reign of Alim Khan. In addition to central-Asian interests the Khante contended with Qing China through borders at Kashgara / Chinese Turkestan. The state was a nominal subject or protectorate of the Qing from 1758 until 1810-17. Khokand harboured White Mountain Khojas who over the next few decades infiltrated Kashgara from time to time and stirred up Uyghers into an anti-Chinese jihad. In the 1820s a Khokand army marched to the borders of Kashgar but declined to attack a Qing force. Significant conflict with the Russians starts from the 1830s.

Firearms were less common than in neighbouring states, with bows still in use throughout the 19th century. Some riders would wear mail and helmets all were noted for their courage. The Khan's guard in 1814 had red turbans where others wore white. Provincial sipahi or militia cavalry were the retainers of clan chieftains or reliable allied Kazakhs and Kirgiz, Tribal or nomads can be Uzbeks, Kipchaks, Khoja or similar. Afghans were likely mercenaries albeit in the 1760s the Durrani put troops on the Kokhand border to watch China. Infantry and artillery would mostly be city defenders. The Army can optionally be of **Feudal Doctrine**.

Kazakh Hordes, Kirghiz or other Steppe Clans

Minor Power

Cavalry	Cavalry	Cavalry																
Khan's Bodyguard  16  <table border="1"> <tr> <td>6</td><td>5</td><td>4</td><td>3</td><td>2</td><td>1</td> </tr> </table> 	6	5	4	3	2	1	Cavalry  12  <table border="1"> <tr> <td>5</td><td>4</td><td>3</td><td>2</td><td>1</td> </tr> </table> 	5	4	3	2	1	Kirghiz or similar Clan Cavalry  12  <table border="1"> <tr> <td>5</td><td>4</td><td>3</td><td>2</td><td>1</td> </tr> </table> 	5	4	3	2	1
6	5	4	3	2	1													
5	4	3	2	1														
5	4	3	2	1														

Historical Parameters

At War: 1780s+

Allies: Kazakhs, Kirgiz etc, Central Asian states, Chinese Turkistan.

Enemies: Bokhara, Khiva, Khokand, Chinese Turkestan, Qing China. Russia, Tibet.



Kazakh Horde, Kirghiz etc - Brigade List

Minor Power

Kazakh Bde	Kirghiz etc Bde	Army Assets
0-1 Khan's Bodyguard 2-4 'Cavalry'	2-5 Kirghiz or similar 'Clan Cavalry' or all 'Cavalry'	0-6 Partizans 1

This list covers the Kazakh Hordes, and clans of the steppe, including the Kirghiz, Uzbek, Kalmyk, Oriat, Dzungarians, Bashkirs, Nogai, Tajiks or other similar equestrian peoples.

The armies of these nations were a shadow of the terrifying, disciplined and efficient forces of their famous Mongol or Turkic predecessors. They were noted by their more structured enemies as being expert raiders and robbers but no match for organised soldiers, they were especially nervous of facing artillery.

The Kazakh Hordes included the *Great Horde* in the far east, the *Middle Horde* in the North, the *Little Horde* to the east and north of the Caspian Sea and an off-shoot *Bukei Horde* of the Volga.

From the 1730s the Middle and Little Hordes became Russian protectorates; the Little Horde was absorbed in 1824 and the Bukei in 1803. The others were eroded and defeated by Russia and / or attacked by Asian nations during the remainder of the 19th century. 'Steppe Clan' groups include the Kirghiz and others as listed above. Crimean Tartars may be included elsewhere and note the groups from the Caucasus are in a separate list.





























An army must be based on either a Kazakh Horde or a Kirghiz or similar clan. If the former it can include only the Khan's bodyguard and 'cavalry' troops types organised into 'Kazakh' brigades. If the latter it can include only the 'Cavalry' troop type or the 'Kirghiz or similar clan' troop type. Either type of army can include allies from the other, as shown, to diversify their army. Where a nation had control over cities or forts that might provide infantry or artillery use one of the allies as shown to field such troops.

The Kazakh hordes and many of the other races were slow adopters of firearms and used bows in stead of or in addition. Kirghiz with the SK2 value represents expert shooting, often dismounted, with long-barrel and possibly rifled weapons fitted with bipod rests. Clans might wear headbands and streamers in the colour of their tribal flag for recognition.

The Army can optionally be of **Feudal Doctrine**.

Turkmenia

Minor Power

Cavalry	Infantry	Artillery
Sadar's Guard (0-2)  18  ← 5 4 3 2 1 	Matchlock-men  10  2    5 4 3 2 1 	Light Guns  5 2 1   5+ 
Cavalry  14  1 ← 5 4 3 2 1 	Town Defenders, Slaves  6  1   5 4 3 2 1 	Earthworks A Turkoman army may purchase up to two x 4BW-long section of tethered camels counting as Earthworks, for 4 points Each. They must be placed during set-up within 1BW of a Matchlock unit.
Dependent Clan  12  1 ← 5 4 3 2 1 	Town Defenders with Pole-scythes  6  1   5 4 3 2 1 	

Historical Parameters

At War: 1780s+.

Allies: Rebel Persian Nobles 1810-15 (include no uniformed troops).

Enemies: Persia, 1796, 1809, 1813, Turkoman rivals 1780s+.

1 Sardar's Bde 1-2 Sardar's Guard 0-2 'Cavalry'	Cavalry Bde  2-4 'Cavalry'	Army Assets 0-1 Light Guns 0-2 Matchlock-men 0-6 Partizans 1
1 Town Bde 1-3 Town Defender or Slaves (any)	Dependent Clan Bde 2-4 Dependent Clan	

Turkoman raiders excelled at traditional steppe horsemanship and favoured skirmishing and enveloping their enemy. Riders might keep a favoured war-horse spare for battle while travelling on pack horses. Infantry could be given asses or camels to aid mobility. A makeshift fort of kneeling camels would be defended by infantry; skirmishers were sent out in front and cavalry protected the sides.

Town defenders can include women throwing pots of boiling water or loading weapons for their menfolk. Some defenders used a pole-arm of scythes fixed on poles which is given the benefit of counting as the Pikeman Trait. Artillery was rare and probably captured from Persian forts.

Baggage can include hostages used as a human shield. The Army can optionally be of **Feudal Doctrine**.

Historical Parameters**At War:** 1758+.**Allies:** Afghanistan, Mogul and Successors.**Enemies:** Persia, Afghanistan 1790s+, Oman, 1790s+.

This list covers the Kalat Khanate of Baluchistan in modern Pakistan. The Khanate is considered a separate entity following a treaty with Afghanistan in 1758. The treaty was struck as the Afghans failed to daunt the Khanate after three battles and a siege. The Khanate remained linked to Afghanistan and reportedly sent 25,000 warriors to help at the Battle of Panipat against the Marathas in 1761. In 1765-66 Baluchi 'swordsmen' were part of a 12,000-strong force that helped the Moghuls and Afghans fight the Sikhs.

In addition to the threat of conquest from Afghanistan, Persians in the west and south were an enemy and Oman captured cities on the Makran coast.

The most famous leader was Mir Noori Nasser Khan 'the great' r.1749-1794 who expanded the state, established civil institutions and unified the tribes. The land appears to have had a number of small or large clans, of varying wealth, scattered over the significant barren, mountainous or desert areas of Baluchistan. The related Amirs in Sind may be covered elsewhere. Many tribes of the Makran coast were independent after Mir Noori Nasser Khan's death.

Camel riding appears more popular in the west and south and horses in other areas. The Khan kept a special reserve of 2000 excellent camels for campaigning.

Several accounts mention combatants riding two men to a camel, back-to-back. The front man might be armed with a bow or fire-arm, sword and shield while the rear man had a long sword and lance. Other accounts say that a few men might have rusty pistols. Some were single riders of camels or horses. Tribal data from Makran suggests 10% were cavalry and the rest infantry. Artillery was introduced after Panipat when the Khan maintained a small battery of four guns, later in the 19th century the central army had 300 gunners.

In some tribes firearms were scarce, but others were noted as 'capital marksmen'. Infantry fighting for Oman were naked to the waist and armed with a crooked toffung (matchlock), knife and a straight two-handed sword. Other men wore white or blue knee-length shirt, similar or striped trowsers, checked or blue turban and kummerbund. A traditional saying had young men as white-clad and possessing the six weapons of war; the shield, gun, dagger, arrows, sword and horse. The warriors of a clan leader were bound to serve annually for 40 days at their own expense.























Mir Noori Nasser Khan was noted as copying Afghan and Indian military organisation; he formed a standing body of 1200 men - the *Dasta e Darbar* 'palace regiment'. Later in the century the regular forces were 300 gunners, 500 foot, 500 cavalry and a further 1000 'auxiliaries'. Armies included doctors, poet-musicians, 'chari' spies / scouts, and specialist artizans to repair weapons and gear.

One battle formation is given as: the *Dasta e Khas* 'Special Division' of 10,120 men of 18 tribes (ranging from 2000-50 men each) deployed centrally with the palace troops (in reserve?), the *Dasta e Doem* 'Sarawan Lashkar' 'Second Division' deployed on the right with 5,800 men of 14 tribes (ranging from 800-50 men) and the *Dasta e Soem* 'Third Division' deployed on the left of 4,500 men of 11 tribes (ranging from 1000-100 men). The divisions appear to be geographic or ethnically based. A theoretical battle formation was cavalry leading an assault followed up by swordsmen and spearmen.

The Khante was taken over by the British in 1839. An allied contingent is a 'what if' assuming a senior partner would help their junior. The Omani enemy may also be a 'what if' given their aggression in the area may well have been against cities no-longer under Kalat rule.

Kalat Khanate - Army tablet

Minor Power

Cavalry	Infantry	Artillery
Two-man Camels  14  1 5 4 3 2 1 	Musketeers  11  2 5 4 3 2 1 	Artillery  5 2 1  5+ 
Cavalry  15 6 5 4 3 2 1 	Spearmen, Swordsmen  8  1 5 4 3 2 1 	 All or none of a Musketeer or Spearman-swordsman brigade can given the Camel Mounted Infantry Trait at +1 point each.
Khan's Palace Cavalry  16 6 5 4 3 2 1 	Khan's Palace Infantry  12  1 6 5 4 3 2 1 	
Camel Rider, Afghan Turkic or Similar Tribe  11  1 5 4 3 2 1 		

Kalat Khanate - Brigade List

Minor Power

Camel Raider Bde 2 2-4 Two-man Camels 0-1 Camel Rider	Cavalry Bde 2 1-4 'Cavalry' 0-1 Camel Rider Afghan or Turkic tribe 	Army Assets 0-1 Artillery 0-2 Khan's Palace Cavalry or Infantry 0-6 Partizans Note: Infantry or Artillery can be assigned only to a brigade with more infantry units than cavalry units. 1
Infantry or Dismounted Camel Bde 2 2-3 Musketeers 2-3 Swordsmen or Spearmen	Musketeer Bde 1 2-3 Musketeers	
Makran or Similar Tribe Bde 2 1 Cavalry or Camel Rider 1-2 Swordsmen or Spearmen 1-2 Musketeers		

Historical Parameters

At War: 1780s+.

Allies: Tribal Arabs or Gulf-state Arabs 1780s+, Kurdish Emirate 1780s+, Ottoman Turks (Mamluk Baghdad) 1790s, Wahhabist Arabs c.1785-1802, Persia 1799.

Enemies: Tribal or Gulf-State Arabs, Wahhabist Arabs from 1780s+, Persia 1783-99, Oman 1799, British 1808+.

The Muntafiq Arabs under Thuwaini ibn Abdullah were a significant regional power. They were the senior partner in an anti-Wahhabist alliance with the Ottomans in the 1790s. They supplied 20,000 troops and the commander Sheik Twyney / Thuwaini, while the Ottomans provided 10,000 men, of which 6000 were cavalry. The campaign was a disaster for the allies and after defeat in battle the Sheik was assassinated by a slave.

Other forces can include those from Bahrein-Utub (as an enemy of Oman, ally of Persia), Al Qaisimi Arabs / Josamy 'Pirates', Beni Lam tribe and Chab. Detailing ethnic / tribal and political diversity is beyond the scope of this work.

Armies should have many flags, green if a descendant of Ali - perhaps with gold lettering of sacred verses - some were black and others of unknown design. Banners might be surrounded with drummers and other musicians.

Clothing can be simple black wool or goat-hair cloaks to the ankles; headdress of bright colours, striped black or white long shirts. The troops from Chab were once described as tastefully sporting a green tunic, loose trousers, crimson dresses (cloaks?) and lilac cloth turbans.

Asgailees mercenary matchlock-men were noted as efficient and loyal to their paymasters, they are given the doubt to not be Rabble as some at least formed a defensive square of camels to fight from behind.

Cities often contained guns of various quality ranging from hopeless to adequate. Prince Mobader Khan of Chab had a battery of Portuguese guns described as eight long 9-pounders and two iron howitzers. They were old but well maintained. He could field 6000-7000 cavalry and 15,000 infantry and nomads. The petty princelings were keen to capture more guns for their cities.

It is unlikely artillery would be removed far from forts so any fielded will have to assume the city is just off table behind the army.

Negro slaves accompanied forces and can be combatants in the ranks - especially for the Josamy. These might be armed with a long straight sword, spears and a round hide shield with a gilded boss. Nomad infantry were either clad in rags or loin cloths, their weapons could be as bad as just clubs for poorer individuals.

An army must be based on either Tribal or Gulf-State and not include items listed as only for the others. Allies can be of either type or indeed one allied contingent from both.

Tribal Arabs can also represent those in Africa such as Beja, Berber or similar people. A Tribal Army can optionally be of **Feudal Doctrine**.

Tribal or Gulf-State Arab - Army Tablet

Minor Power

Cavalry

Infantry

Artillery



Cavalry  **16**

←

6	5	4	3	2	1
---	---	---	---	---	---

4+

Swordsmen or Spearmen  **8**



 **1**  

5	4	3	2	1
---	---	---	---	---

4+

City Artillery  **8**

2	1
---	---

  **5+** **6**



Nomad Cavalry or Camel Riders  **12**

 **1** ←

5	4	3	2	1
---	---	---	---	---

3+

Asgailee Mercenaries  **13**



 **2**  

6	5	4	3	2	1
---	---	---	---	---	---

4+

City Artillery  **5**

2	1
---	---



  **5+** **6**

Earthworks

An Arab army may purchase up to one x 4BW-long section of tethered camels counting as Earthworks, for 4 points.

They must be placed during set-up within 1BW of an Asgailee unit.

Nomad Infantry or City Defender  **6**



 **1**  

5	4	3	2	1
---	---	---	---	---

3+

 Note: Any infantry can be given the **Camel Mounted Infantry** trait for +1 point each.

Matchlock-men  **8**

 **1**  

5	4	3	2	1
---	---	---	---	---

4+

Tribal or Gulf-State Arab - Brigade List

Minor Power

Cavalry Bde

- 1-2 'Cavalry' 
- 1-3 Nomad Cavalry or Camel Riders

City Bde

- 2
- 1-2 Swordsmen or Spearmen
- 1-2 Matchlock-men
- 1-4 City Defenders

Army Assets

- 0-1 Asgailee Mercenary
- 0-1 Artillery (any) only if Gulf-State

0-6 Partizans (only if Tribal)

Note - Army assets may not be formed into a separate Brigade, Artillery if used must be attached to a City Brigade.

Nomad Bde

- 2
- 2-4 Nomad Cavalry or Camel Riders
- 0-2 Nomad Infantry

1

Historical Parameters

At War: 1783+.

Allies: Russia 1783+, Caucasus Khanates 1783+, Imereti, Mingrelia, etc (use this Georgian list) 1790+.

Enemies: Persia 1795-6, 1800-1, Caucasus Khanates 1783+, Avar Khanate 1800-01, civil war 1783+.

This list covers Georgia as the combined crown of Kakheti and Kartli. The nominal 1783 start date is the Treaty of Georgievsk with Russia - which required Georgia to shun Persia in return for Russian protection and money. The famous Georgian King Heraclius II (1720 -1798) was described as the 'Frederick of the east', he served as a vassal commander in the forces of the great Persian war-lord Nadir Shah.

Georgia was unfortunately placed between slave-raiding Turks to the south and west, Leshgi tribes to the east, expansionist Russia to the north and Persia to the south. Heraclius undertook a program of modernising his nation which included establishing a national levy of one man per household that received training from Russian instructors and was organised along Russian lines. The *morige lashkari* was a further compulsory levy of all able-bodied men, the former levy may have evolved into this or stood along side it. Heraclius also engaged 2000 Greek artificers to build new modern artillery the cost of which appears to have exhausted the treasury.

A national mobilisation effort which included allies and mercenaries was in the order of 25,000 men in the 1790s and one estimate from the late 1770s suggested 40,000.

After Persian sack of Tblisi (1795) and Heraclius' death the nation spiralled into succession crises, civil wars, raids and finally Russian exasperation at her puppet rulers led to annexation.

The closely related state of Imereti and the neighbouring smaller Mingrelia, Guria, Svaneti and Abkhazia can use this list (see later) or be considered a Georgian ally using this list - either way they can not use Khevsours, non-allied Russians, Levy or Morige Lashkari troops as their allied brigade. These smaller states might be allies of Russia or the Turks.

Khevsours were fierce mountain men famous for killing Russians (when not otherwise engaged as panther-hunters) and wearing mail, many photos of such men survive. Among them was the Argavi bodyguard that swore an oath to die fighting for their king - this they did at the Persian sack of Tblisi.

It is not clear if noble cavalry were lancers, an illustration dated probably 1780s, at the latest, shows them with armour, lances and shields looking a lot like Persian joushan-pushan troopers.

For fans of extreme 'what ifs' a faction of Egyptian Mamluks in 1803 asked permission from Russia to return to the Georgian homeland they were abducted from as youths. The request was denied but such a force could be an interesting hypothetical enemy or ally.

Georgia - Army Tablet

Minor Power

Cavalry

Infantry

Artillery

Guards, Aznavur (0-1) 21

 ←

6	5	4	3	2	1
---	---	---	---	---	---

 5+

Russian Renegade or Georgian Guard 15

 1

6	5	4	3	2	1
---	---	---	---	---	---

 4+

Traditional Artillery 5

2	1
---	---

 5+  6

Noble, Circassian or Khevsaur Cavalry 15

6	5	4	3	2	1
---	---	---	---	---	---

 4+

Khevsaur Highlanders 12

 2   

6	5	4	3	2	1
---	---	---	---	---	---

 4+

Modern Artillery 12

2	1
---	---

 4+  6

Leshgi, Armenian or Abkhazian Cavalry 12

5	4	3	2	1
---	---	---	---	---

 4+

Georgian, Mercenary or Tribal Musketeers 9

 2  

5	4	3	2	1
---	---	---	---	---

 4+

Russian Artillery 10

2	1
---	---

 4+  6

Turkic Tribe, Leshgi or Cossacks 11

 1

5	4	3	2	1
---	---	---	---	---

 3+

National Levy 7

 1 

5	4	3	2	1
---	---	---	---	---

 3+





Morige Lashkari 6

 1  

5	4	3	2	1
---	---	---	---	---

 3+

Argavi Guards 13

 1   

6	5	4	3	2	1
---	---	---	---	---	---

 5+

Earthworks

A Georgian army may purchase up to two 4 BW-long sections of earthworks, for 4 points each. They must be placed during set-up within 1BW of an artillery unit.

Such works appear to have been built overnight for the second day of the battle of Krtsanisi.

Georgia - Brigade List

Minor Power

1	<p style="text-align: center;">Elite Cavalry Bde</p> <p>1-2 Noble, Circassian, or Khevsaur Cavalry</p> <p>1-2 Leshgi, Armenian or Abkhazians</p>	<p style="text-align: center;">Infantry Bde</p> <p>2-4 Georgian, Mercenary or Tribal Musketeers </p>	<p style="text-align: center;">Army Assets</p> <p>0-1 Argavi Guards 0-2 Modern Artillery 0-1 Traditional Artillery 0-1 Guards, Aznvaurs 0-1 Cossack 0-1 Russian Renegade or Georgian Guard</p> <p>0-3 Partizans</p> <p>Army Assets can not be formed into a Brigade of their own.</p> <p>Cavalry Assets can be attached only to a Cavalry Brigade.</p>
2	<p style="text-align: center;">Leshgi or Turkic Cavalry Bde</p> <p>2-4 Leshgi <i>or all</i> Turkic Cavalry</p>	<p style="text-align: center;">Levy Bde</p> <p>2-4 National Levy 0-1 Artillery (any) 0-2 Morige Lashkari</p>	
1	<p style="text-align: center;">Khevsaur Highlander Bde</p> <p>2 Khevsaur Highlanders</p>	<p style="text-align: center;">Morige Lashki Bde</p> <p>2-5 Morige Lashkari</p>	
1	<p style="text-align: center;">Russian Bde</p> <p>1-2 Russian Musketeer (any) from the Russian list 0-1 Russian Artillery (from this list)</p>		

'Georgian' Minor states

Minor Power

Imereti 1783-1812

Allied to Georgia; from 1804 allied as a subject of Russia, from 1810 in revolt and an enemy of Russia.

Mingrelia 1783-1811

Allied to Imereti to 1803, allied with Russia against the Turks 1806-10, allied to Russia vs Abkhazia 1810. In 1811 absorbed by Russia. From 1804 the nation and armies can be led by Princess Nino on behalf of her infant.

Svaneti 1783 +

Allied as a subject of Mingrelia.

Guria 1783-1811

Allied to any of the other Georgian states, absorbed by Russia 1811.

Abkhazia 1783 +

Allied to Turks to 1809, thereafter Russia. The rulers and nobles of Abkhazia would change allegiance and religion between the two.

Cossack Invasion of India - 1801

Minor Power

Cavalry

Artillery

Atman's Sotnia (0-2)



16



1

6 5 4 3 2 1



Cossacks



11



1

5 4 3 2 1



Horse Artillery



17

2 1



4+



This force represents the abortive Cossack invasion of India from January to March 1801. The force consisted of 22,507 Cossacks and 24 guns under Generals Platoff and Orloff - Atman of the Don Cossacks.

The invasion idea was the brainchild of Emperor Paul and died with his assassination on 24 March 1801. The Cossacks were marching to be the advance force of a secret combined army of 70,000 French and Russians. Such an army was never assembled so this force has at least one foot firmly in the 'what if' status.

General Messena was slated to lead the French if you want to re-create the hypothetical invasion.

The Cossacks were to march overland to the Persian port-city of Astrabad on the Caspian where they would link with French and other Russian forces who would be shipped there from the Caucasus. As a further 'what if' an advanced force of Russian infantry is represented here by the Russian brigade which is a pastiche of typical Russian armies in the Caucasus.

Possible Enemies (or allies?): of Persia, Turkmenia, Khiva, Bokhara, Afghanistan, Sikhs and British India.

The Army can optionally be of **Feudal Doctrine**.

Cossack Invasion of India - Brigade List

Minor Power

Russian Bde

1

2-4 Russian Musketeer (any)
0-1 Russian Battery (any)
0-1 Russian Dragoons

Choose Russians from their list.

Cavalry Bde

0-1 Atman's Sotnia
3-6 Cossacks



Army Assets

0-2 Horse Artillery

0-6 Partizans

1

Historical Parameters: to 1803 if **Avar**, to 1804 if **Ganja**, to 1806 if **Baku or Derbent**, to 1805 if **Karabagh**, to 1827 if **Naskshivan**, to 1830s+ if **Kurds**.

At War: 1780s+.

Allies: Caucasus Khanates, Persia, Ottomans, Russia, Georgia to 1801, *If Kurdish Emirate*, also Tribal Arab and Basra 1788+.

Enemies: Persia, Ottoman Turks, Caucasus Khanates, civil war, Georgia to 1800, Russia 1790s+, Mamluk Baghdad 1780s+.

This list covers smaller states in the Caucasus, the Avar Khanate and Kurdish Emirates. At times these were allies or subjects of the Ottomans, Persians and into the 1800s, Russia. For simplicity Persia, Russia and the Turks are shown as potential allies and enemies throughout the period and for all the states - feel free to untangle the exact diplomatic relations in your spare time. By the late 1820s (post the Russo-Persia 1826-28 war) most were absorbed by their larger neighbours. Some dominated or allied with other smaller states.

Forces were feudal or mercenary troops, however a few states raised European-inspired regular infantry but did not have the resources to do so in a significant way. The sarbaz-inspired regulars of Naskshivan in 1812 were especially woeful. Many of the states' cavalry included riders wearing mail and or using shields, a minority might have bows in addition to firearms. Leshgi mercenaries were commonly available for hire - sometimes by both sides of a conflict. They had a reputation for wildness and robbery. They can be represented by the generic 'cavalry' or their named classification.

The Avar Khanate represents the last autonomous state of the people who could trace a lineage back to ancient times. Their famous leader was the charismatic Omar Khan who fought a doomed war against the Russians. His army, probably of no more than 15,000 men, was destroyed at the battle of Kakabeti or the Yora / Iora River in 1800. The Avar cavalry charges were ruined by Russian artillery. His forces included mercenaries and some Georgian exiles, however a promised Persian allied contingent did not make it to the conflict in time. Some sources suggest the Persians sent only money.

The larger Caucasus states include Ganja, Karabagh, Erivan, Baku, Nakshivan, Shirvan, Quba, Shaki, Derbent, Taylish, Tarki, Javad, Khoy and Lesghi tribes. The 1812 insurrection of Georgian Prince Alexander included Georgians, Lesghi mercenaries and Circassians - count this as another Caucasus force. Javed Khan of Ganja told the Russians that they could take the city over his dead body. In 1804 he was true to his promise and in one account died fighting while sitting astride one of his 48-pounder iron guns. Other heavy guns can be those of Karabagh / Sushu who benefited from the Persians simply abandoning their battery as they lifted the siege in the 1780s and rushed to fight enemies in the east. After 1804 Erivan can be covered by the Persian list.

Russian units could be found helping some khanates during the 1804-13 war with Persia.

Kurdish Emirates can include the larger polities of Baban, Ardalán, Hakkari, Bohtan and Soran. These were buffer states between the Ottomans and Persia, while the first few were also in the Russian sphere of influence following the fall of Georgia. The degree of their independence might depend on the state of unrest in their larger neighbours.

Kurd warriors were known for their horsemanship, dash and resolve. Some clans or individuals wore armour and many used lances. The Hakkari were more 'tribal' and ethnically diverse with under-classes of Christian or Yezidi groups. Civilians from Tabriz were armed in one conflict as an emergency measure. The Baban Emirate was part of a coalition including Muntafik Arabs and the ruler of Basra who attacked Mamluk Baghdad in the late 1780s.

A famous leader of the Soran Emirate was Muhammad 'Kor' ('the blind' - in one eye) who conquered surrounding peoples from 1813 and later engaged Persian and Turk experts to make artillery and firearms. His forces were described as artillery, 10,000 cavalry and 20,000 infantry but also as a horde of 50,000 irregulars and a small standing force. He was a significant threat to the Turks into the 1830s. An Avar Army can optionally be of **Feudal Doctrine**.

Avar or Caucasus Khanates, Kurdish Emirates

Minor Power

Cavalry	Infantry	Artillery
Nobles 21 ← 6 5 4 3 2 1	Musketeers 11 2 5 4 3 2 1	Traditional Artillery 5 2 1 5+
Cavalry 15 6 5 4 3 2 1	City Defenders or Subject Races 6 1 5 4 3 2 1	Heavy Artillery 10 2 1 5+
Kurd Cavalry 16 ← 5 4 3 2 1	Armed Civilians 6 1 5 4 3 2 1	Turco-Persian Trained Artillery (1812+) 8 2 1 5+
Turkic Tribe or Leshgis 11 1 5 4 3 2 1	Sarbaz or Regulars 9 1 6 5 4 3 2 1	<p>Note: An army must be based on one of Kurd, Caucasus or Avar. Allies can be of the other types. 'Kurd cavalry' must be part of a Kurd army or allied contingent.</p> <p>For the Russian Musketeer, use troops from the Russian list.</p>

Avar, Caucasus or Kurdish Brigade List

Minor Power

Noble Bde 2 0-1 Nobles 2-3 'Cavalry' (any)	Infantry Bde 2-4 Musketeers 1-2 City Defenders or Subject Race	Army Assets 0-1 Traditional Artillery 0-1 Heavy Artillery (<i>not Avar</i>) 0-1 Russian Musketeer, (<i>not for Avar or Kurds, 1804+</i>) 0-1 Sarbaz or Regular (for Kurds or Nakshivan) 0-1 Turco-Persian Trained Artillery (for Kurds) 0-6 Partizans if Avar 0-3 Partizans for others Army Assets can not be formed into a Brigade of their own.
Leshgi or Turkic Bde 2 2-4 Turkic Tribe or Leshgi	City Bde 2 2-4 City Defender or Armed Civilians 0-1 Traditional Artillery	
Cavalry Bde 2-4 'Cavalry' (any)		

Historical Parameters

At War: 1798-1801. **Enemies:** Malta, Ottoman Turks, British in Egypt, Mamluks, 1799-1801.

The infantry for Napoleon's invasion of Egypt was initially composed of veterans from the Italian campaigns. After 1800 the army was wearing out or included impressed European civilians, Greeks, Copts, Egyptians or even Sudanese ex-slaves in the ranks to thus deserve possible 'conscript' status. Some tough units such as the Guides a Pied and those battalions of converged flank companies (one unit included three extra grenadier companies) could be Elite.

Infantry were organised into in three-battalion demi-brigades of line or legere but often one or two of the battalions were detached. Some battalions were disbanded and distributed to other units later in the campaign. Three lone battalions were also part of the expedition. Using 'brigades' as per the existing French list can thus represent small divisions of two demi-brigades. The nominal initial divisions were nine battalions; two demi-brigades of line and one of legere plus a company of Italian sappers. This structure did not last into the campaign.

Demi-brigades included 'battalion' guns, tracking the number is difficult given the different historical returns - guns were supplemented by the army artillery including light horse-artillery parcelled out to the infantry. Even the dromedaries were given some guns. The Legions might be given captured Austrian or Piedmontese 3-pounders. A unit of captured Turk howitzers was used in the siege train. Some foot artillery companies were under-strength and could thus be classed as three-dice units. One unit of horse artillery, that was attached to cavalry, was 8-pounders. At least some of the horse artillery used wurst wagons.

Cavalry were dragoons and a single unit of hussars and a single unit of chasseurs (the latter commanded by our man Lasalle). Treat the Mounted Guides as a dragoon unit, they possibly deserve better. Cavalry units were often under-strength so you can assume some units represent two smaller regiments.

Unique troops for Egypt included the Nautical Legion and non-French legions. They were 'legions' by virtue of combining infantry and guns, none seem to have had more than two battalions and only the Copts had a cavalry component late in the wars and that was only a single troop apparently brigaded with the cavalry.

The **Maltese Legion** included volunteers from the Grand Master's disbanded army including a company of guard grenadiers - but it mostly was conscripts who deserted in a constant dribble. They had a poor reputation despite receiving French training and being initially stiffened by a company of French grenadiers. They were disbanded during 1799.

The **Nautical Legion** was comprised from sailors without ships following the British destruction of the French Navy. They were organised as infantry but seem to have suffered from army-navy jealousies exacerbated by the expeditionary force now being stranded due the sunk ships. They were disbanded during 1799 and later reconstituted in 1800.

Local **Coptic** orthodox Christians were formed into a Legion, they appear to have been fair troops and had some special prowess at street fighting. The **Greek Legion** manned the supporting flotilla and provided infantry, these were also reasonable troops and many returned to France with Napoleon.

Local Guides - foot and mounted companies of locals were attached to the French guides formations. They are probably too few to be included as separate units but can add colour to your army as odd bases or markers.



























































Janissaries and National Guard. A unit of local 'janissaries' was formed in 1798, albeit it is not clear if it had a military role rather than being a police force. A National Guard of French and other Europeans was proposed to be created in 1800, it is not clear if this unit existed other than on paper.

Syrian / Republican Mamluks. A unit of local cavalrymen was recruited and it appears to have become a standing and better disciplined force toward the end of the occupation.

Dromedaries - the famous and colourful unit of the dromedaries was an innovation to deal with local conditions. The unit was initially armed with lances suggesting it would fight mounted but these were later discarded and the unit appears to have been 'mounted infantry' thereafter.

French Army of the Orient - Army Tablet

Major Power

Cavalry	Infantry	Artillery
Dragoons or Guides (0-6)  20  6 5 4 3 2 1 	Elite Infantry (0-2)  20   6 5 4 3 2 1 	Field Artillery  12 2 1     4+ 
7th Hussars or 22nd Chasseurs (0-2)  17 6 5 4 3 2 1 	Veteran Infantry  18   6 5 4 3 2 1 	Reserve Artillery (0-1)  14 2 1    4+ 
Syrian or Republican Mameluks  12 5 4 3 2 1 	Conscript Infantry  16   6 5 4 3 2 1 	Horse Artillery  12 2 1    4+ 
Dromedaries  14  1 ← 5 4 3 2 1 	Janissaries or National Guard (0-2)  6    5 4 3 2 1 	Under-strength Artillery  10 2 1   4+ 
 Instead of the dromedaries being a cavalry unit, they can be represented as a French infantry with the camel- Mounted Infantry Trait for +1 point.	Maltese Legion (0-2)  7   5 4 3 2 1 	
Ababda Arabs  12  1 ← 5 4 3 2 1 	Nautical, Greek or Coptic Legion (0-4)  14  2 6 5 4 3 2 1 	

Note the numbers in brackets above next to troop name represent the maximum of the type that can be fielded in an army - some may appear in brigades or army assets, either way the maximum applies.

An army **must have more units of Dragoons** than the total of Hussars and Chasseurs if any cavalry is used.

An army must have more units of French non-Legion infantry than the total of other infantry.

If using Regimental guns Advanced rules, all infantry units, including the Dromedaries but not the Janissary / National Guard, can have them.

2	Cavalry Bde	1-3 Dragoons 0-2 Hussar or Chasseur 0-1 Horse Artillery (any)	1	Infantry Bde	3-6 Non-Legion French Infantry (any) 0-1 Legion (any)  0-1 Artillery (any)	<p style="text-align: center;">Army Assets</p> 0-1 Foot Guides (Veteran or Elite Infantry) 0-1 Mounted Guides 0-1 Dromedaries 0-2 Legion (any) 0-1 Syrian or Republican Mameluks or Arabs 0-1 Reserve Artillery, Horse Artillery or Under-strength Artillery <i>0-3 Sapeur</i> <i>0-2 ADC</i> Note - Syrians or Republican Mameluks may not be attached to an Infantry or City Guard Brigade.	
	Light Cavalry Bde	1-2 Hussar or Chasseur 0-1 Syrian or Republican Mameluks		City Guard Bde	1-2 Janissary or National Guard 0-1 Conscript Infantry or Legion 0-1 Artillery (foot only)		
1							3

Unique weapons

Napoleon issued his men with an anti-cavalry spike which appears to have been quickly discarded, even if he was still advocating such a thing in his second exile. The disciplined French squares and artillery were sufficiently strong to resist Mamluk cavalry charges without recourse to spikes. If there is a 'what-if' desire to represent spikes, classing the infantry as Part-Pike might do.

If anybody knows more about the flame-thrower used against Cairo revoltors let me know.

'What ifs'

A force of Ababda Arabs (200 is mentioned at one point) joined Desaix in southern Egypt in 1799-1800 and trained along side his men, they are included above but may deserve 'what if' status as they do not seem to have fought in any significant action. It appears the Arab upper classes were happy to help the French but the lower classes remained hostile.

The Mamluk leader Murad Bey agreed, after their main armies were defeated and pursued into the south, to become an ally of the French against the Turks. He was given control of a southern region and the title 'Prince Governor for the French Republic' but died a year later in the great plague and before any military assistance (or much tax) could be sent to the French.

The 'City Guard' Brigade above assumes the troops therein had a military capacity, which is far from certain.

Tripoli

In 1789 Napoleon negotiated an agreement with the Pasha of Tripoli to permit the landing of French troops and supplies to then be transported to Cairo. However when Admiral Ganteaume attempted to land 4000-5000 troops at the Pasha's city of Derna (east of Tripoli), in June 1801, the local population took up arms to oppose the landing and the attempt was called off least the patrolling British fleet arrive mid disembarkment.

So as a 'what-if' a French in Egypt army of 1801 could include reinforcements landed from Toulon. I have not been able to find information on the composition of the 4000-5000 troops.

Historical Parameters

At War: 1799-1803.

Allies: Ottoman Turks (1799-1803).

Enemies: French Army of the Orient (1799-1801).

This list covers the British forces used in concert with Ottoman armies to expel the French from Egypt. One force landed from the Mediterranean and another via India and the Cape landed on the Red Sea coast. The main Mediterranean landings occurred in 1801 so the 1799 date represents the British naval forces aiding the Turks against Napoleon in the Levant and thus is a slightly early 'what-if' start date for land action. The 1803 end date is when the British left Egypt.

The force included a number of colourful non-British units and new rifle units that would later become a famous element of British armies. The army's performance in the low countries in 1799 was far from spectacular and care was taken to intensively train the expedition in beach landing. It is not clear how proficient the troops were compared with later armies and some different classifications are presented here - if you think them too good or too poor, change them.

'European' infantry can include; Swiss, De Roll's, Dillon's, de Watteville's, Chasseurs Britanniques, Minorca Regiment, Ancient Irish Fencibles (who may be better classed as any other British infantry) or Marines.

'Rifle Battalions' can be the Experimental Corps of Riflemen in green and black uniforms or Corsican rangers in green jackets and grey or blue trousers, Lowenstein's Jagers in a uniform of the style of Austrian Jagers and the Perthshire Rifles. If the last three units are not classed as Rifles they can be classed and count as the other European (or British if Perthshire) infantry units.

The colourful Hompesch Mounted Rifles / Hussars / Light Dragoons in red uniforms can be included as one cavalry unit.

Sepoys include those from Bombay and Madras, artillery for a brigade with these Indian Native units can also include Bombay and Madras companies. Sepoys can be either +3 or +4 Resolve, the difference being a grenadier component. The Red Sea force also included an experimental horse artillery troop.

The British infantry included Highlanders.

The British and French both experimented with using camels as artillery draft beasts for lack of horses, this met with limited success.

British in Egypt - Army Tablet

Major Power

Cavalry

Infantry

Artillery

Light Dragoon or Hompesch Hussar  **17**

6	5	4	3	2	1
---	---	---	---	---	---

5+

Foot Guard (0-2)  **24**

7	6	5	4	3	2	1
---	---	---	---	---	---	---

5+

Foot Artillery  **10**

2	1
---	---

4+ **6**

Foot Regiment (veteran)  **19**

6	5	4	3	2	1
---	---	---	---	---	---

4+

Horse Artillery (0-1)  **12**

2	1
---	---

4+ **6**

Foot Regiment (elite)  **21**

6	5	4	3	2	1
---	---	---	---	---	---

5+

Rifle Battalion (0-3)  **20**

6	5	4	3	2	1
---	---	---	---	---	---

4+

European Regiment (0-5)  **16**

6	5	4	3	2	1
---	---	---	---	---	---

4+

Indian Sepoys  **13** **11**

6	5	4	3	2	1
---	---	---	---	---	---

4+ **3+**

Note: the numbers in brackets above next to troop names represent the maximum of the type that can be fielded in an army - some may appear in brigades or army assets, either way the maximum applies.

Note: an army must have more units of 'Foot Regiments' than the total of other infantry units.

The historical 'Brigades' were mostly 2-3 battalions strong but could be within Divisions of up to nine battalions. The brigade structure shown later reflects how 'European or rifle' units might be included in other brigades or in one case where they were grouped.

Cavalry Bde

1 1-3 Light Dragoons or
Hompesch Hussars

Infantry Bde

3-6 Foot Regiment (any)
0-1 Rifle Battalion
0-2 European Regiment
0-1 Foot Artillery



Guard Bde

1 1-2 Foot Guard
0-1 Foot artillery

European Bde

1 2-4 European Regiment
0-1 Foot Regiment (any)
0-1 Foot Artillery

Red Sea Bde

2 2-4 Foot Regiment (any)
1-2 Indian Sepoys
0-1 Foot Artillery or
Horse Artillery

Army Assets

0-1 Hompesch Hussars
0-2 Foot Artillery, Horse Artillery
0-2 Foot Guard

0-3 Sapeur
0-3 ADC

Note - The Hompesch Hussars can be attached to an 'Infantry' Brigade or the Cavalry Brigade.

The Foot Guard can be attached only to an Infantry Brigade, note that the army is limited to two (2) such guard units in total.

3

Historical Parameters**At War:** 1770s - 1811.**Allies:** Ottomans, British in Egypt (1801), Mecca (see the sub-list), British (1807)*.**Enemies:** French Army of the Orient (1799-1801), Ottomans (1770s+), Yemen 1771, Darfur, Sinnar Shayqya 1770s+, British (1807)*.

This list covers the Mamluks of Egypt as an autonomous or semi-independent part of the Ottoman Empire following revolts in the late 1760s. The army thus reflects an Ottoman provincial force dominated by the dashing Mamluk equestrian aristocracy.

The brave riders proved no match for Napoleon's regular infantry in head-to-head fights but their leaders showed dogged resistance to the French occupation. Once the French and then British left Egypt various pro- or anti-Istanbul Mamluk factions, Turkish-appointed officials and restive mercenary warlords contested for power in bloodthirsty conflict.

A sub-list covers the joint forces of the Mamluk leader Murad Bey and Hasan Sharif of Mecca that opposed the French.

Muhammad Ali the Albanian military commander was recognised by the Porte as ruler of Egypt in 1805. His Europeanised army reforms from 1815 may appear in another list. Ali ended the power of the Mamluks by treacherously massacring their leaders in 1811. By the 1830s he was threatening to topple the Ottoman Empire following successful campaigns in Greece, Syria and Africa.

The Sub-list covers the forces inspired by the Ottoman Sultan's call for jihad against the French. He said they were plotting to capture the holy cities in the Arabian peninsula. The force cooperated with the Mamluk leader Murad Bey. An initial wave of 1200 volunteer jihadists were followed by Sharif Hasan of Mecca (a semi-autonomous Ottoman ruler) who organised Red Sea cities to also join his force. The Sharif supplied the jihadists with swords, guns, food and transport. His motives were also financial as he wanted to re-open Egyptian trade routes and restart pilgrimages to the holy cities. It is not clear who was the senior partner in the alliance, the Sharif commanded more and better soldiers but Murad Bey seems to have inspired the locals.

The French eye-witness Denon described the volunteer's arms as; '*three javelins, pike, dagger, pistol and carbine*' which sounds like cavalry equipment, suggesting both foot and cavalry volunteers answered the call. However it is far from clear which troops are being described at different points. It is tempting to see the volunteers as experienced Arab raiding cavalry and unskilled but enthusiastic infantry thus mirroring contemporary Wahhabist forces who were at this date not yet in committed conflict with the Sharif. Such individuals may plausibly have been part of this force.

The Sharif's or Red Sea troops are not well described but they shocked the French with musquetry and grape from prepared trenches at the battle of Benhute (won by the French). Arab flags were noted but not further described.

The jihadists could be recognised by their distinctive green turbans. Some accounts described the volunteers as rashly advancing with poor arms, and being cut to pieces, rather than routing and at other times conducting an orderly retreat unit by unit. This again suggests French accounts are not clearly discerning different troops. Similarly Meccans / jihadists were described as fighting bravely and holding ground, while the Mamluks were happy to swirl about and attempt feint retreats to prompt a rash pursuit into artillery fire.

The British landing of 1807, of about 6000 men, was to support the rebel Muhammad Bey al-Alfi and create confusion for the Turks who were now allied with France against Russia. Al-Alfi died (poisoned?) leaving the Brits with uncertain local support from; al-Alfi's successors, some Arab tribes and the well-armed mobs of Alexandria. The British force was mostly veterans from the battle of Maida but they were defeated by the Egyptians. The force also included a small rocket troop that was largely ineffective. One incident reflected a tactic beloved of wagamers. A square deployed into line to face an infantry attack to only be destroyed by a charge of Egyptian cavalry. An army representing this expedition is best represented as a slightly 'what if' Mamluk-Turk force with British allies against other Mamluk-Turks*.

Mamluk Egyptian - Army Tablet

Minor Power

Cavalry

Infantry

Artillery



Cavalry  **15**



5	4	3	2	1
---	---	---	---	---

4+

Fellahin Spearmen  **6**

 **1**  

5	4	3	2	1
---	---	---	---	---

3+

Artillery  **12**

2	1
---	---

    **5+** **6**



Elite Cavalry  **20**



6	5	4	3	2	1
---	---	---	---	---	---

5+

Fellahin or City Defender  **6**

 **1**  

5	4	3	2	1
---	---	---	---	---

3+

Earthworks

A Mamluk army may purchase up to three x 4BW-long section of Earthworks, for 4 points each.

They must be placed during set-up within 1BW of a foot or artillery unit.



Arab Cavalry or Camel Riders  **12**
(+Albanians and Dellis, 1811)

 **1** ←

5	4	3	2	1
---	---	---	---	---

3+



Albanians  **12**

 **3**  

5	4	3	2	1
---	---	---	---	---

4+

Janissary (conscript)  **10**

 **2** 

6	5	4	3	2	1
---	---	---	---	---	---

3+





Meccan or Jihadist Cavalry  **18**

←

6	5	4	3	2	1
---	---	---	---	---	---

5+

Jihadists  **13**



 **1**   

7	6	5	4	3	2	1
---	---	---	---	---	---	---

3+

Meccan or Captured French Artillery (0-1)  **10**



2	1
---	---

   **4+** **6**

City defenders of the sub-list are those such as at Philoe in upper Egypt who were suspicious of both French and Mamluks. Several such cities supported the Mamluks.

The defenders were (according to Vivant Denon); ‘..some quite naked ... holding a sabre in one hand and in the other a buckler, others had rampart muskets with matchlocks and long pikes’.

Meccan, Ottoman or Red Sea Infantry  **12**



 **2** 

6	5	4	3	2	1
---	---	---	---	---	---



4+

City Defender Wall Guns  **6**

2	1
---	---

  **5+** **J** **6**

Red Sea or other City Defenders  **7**

 **2**  

5	4	3	2	1
---	---	---	---	---

3+

Mamluk Egyptian - Brigade List

Minor Power

Cavalry Bde

0-2 Elite Cavalry
2-5 Cavalry



City Bde

2 1-3 Fellahin (any)
0-1 Artillery
0-2 Janissary or Albanians

Army Assets

0-2 Janissary
0-2 Albanians or
Jihadist (any) in 1799.
0-2 Artillery
0-3 Partizans

Nomad Bde

2 2-4 Arab Cavalry or
Camel Riders

Infantry Bde

2 3-6 Fellahin (any)
0-1 Artillery

Note - Army assets may not be formed into a separate Brigade. Infantry Assets can be attached only to an Infantry or City Brigade.

2

British Allies Bde (1807)*

1 * 2-4 Foot Regt (veteran or elite)
0-1 Dr rolls
0-1 Chasseurs Britanique
0-1 Sicilian Regiment
0-1 Artillery (RA or Naval)
0-1 Rocket Troop

Notes, use British veteran or elite infantry of 1807, the other units can be taken from the British in Egypt list earlier, count the Sicilians as Corsican rangers. Only a single squadron of cavalry was landed. The Brigade (left)* can be split into two Brigades but the numbers of units remains as shown.

Mamluk - Meccan Alliance - Brigade List 1799-1800

Mamluk Cavalry Bde

2 0-1 Elite Cavalry
1-2 Cavalry
1-3 Arab Cavalry



Meccan or Red Sea Bde

2 1-2 Meccan Cavalry
1-2 Meccan, Ottoman
or Red Sea Infantry
1-3 Red Sea City Defender
0-1 Meccan or Captured Artillery
0-1 Fellahin Spearmen



Army Assets

0-2 Jihadist any
0-1 Artillery
0-3 Partizans

Note - Army assets may not be formed into a separate Brigade.

2

Nomad Bde

2-4 Arab Cavalry or Camel Riders
1-5 Fellahin Spearmen

Jihadist Cavalry Bde

1 1-3 Jihadist Cavalry

City Defender Bde

1 1-2 Fellahin Spearmen
1-2 City Defender
0-2 City Defender Wall Gun

Jihadist Infantry Bde

2 2-5 Jihadist

One of these brigades counts as Essential depending on who of Murad Bey or Sharif Hasan of Mecca you see as the senior party.

Note the green shaded boxes simply denote the different origin of the troops they are Organic brigades, not Reserves.

The small number of Jihadists in the main list above represents the first wave before the main army landed.

Mameluk or Arab Infantry Bde

2 3-6 Fellahin (any) or Tribal Arab
0-1 Artillery

Note: this army may not have more than three (3) non-wall gun Artillery units.



Note: 0-4 infantry can be made **Camel Mounted Infantry**, at +1 point each.

Historical Parameters

At War: 1780 - 1831.

Allies: Tribal or Gulf State Arabs, Kurd Emirate, Persian rebel (use no uniformed troops).

Enemies: Persia 1776+, Tribal or Gulf State Arabs, Wahhabists 1802+, Kurds, Ottomans 1810-16.

This list covers the Georgian Mamluk semi-independent rulers of Baghdad / southern Iraq starting with Suliman the Great r.1780-1802 and ending with the Porte's removal of Dawud Pasha r.1815-1831.

Georgian guard Mamluks, initially 2000 strong, asserted independence from Istanbul in the 1750s. The Porte attempted military interventions to impose non-Georgian leaders but these were not successful. There was significant conflict between Baghdad and Istanbul in 1776-80 and 1810-16.

The Mamluks were originally from Georgia and the Caucuses, however unlike the Egyptian Mamluk aristocracy those in Baghdad were not initially part of a separate state from the Ottomans with a history going back to mediaeval times.

The army has elements of a standard Ottoman army but with a greater reliance on local tribal forces and mercenaries. The local janissaries were described by European observers as woeful, with about half barely deserving to be called troops. 'Levy' is used for any non-janissary low quality infantry. 'Fellahin' translates as farmer and is used in other related lists regardless of their civilian occupation.

The Baghdad rulers united with tribal Arabs to oppose the incursions of raiding Wahhabists; the allies' campaign ended in disaster.

Unusual items for this army includes a Georgian guard armed with scimitars, pistols, matchlock and battle-axe and an Asgailee Arab mercenary guard element. The Georgian guard may well have been a dismounted cavalry formation. The guard or standing regular troops were recorded variously up to 5000 strong - which could mean the better quality cavalry, infantry or both.

Dawud followed the trend of many eastern leaders in engaging Europeans to reform his infantry and artillery, in this case apparently as a separate development from the Ottoman *nizam-i-cedid*, but presumably inspired by them or the Persian sarbaz. His instructors seem to have been French and possibly British. His infantry were described as trained and clad in French style which was not further defined. A French officer instructed the making of artillery.

The European reforms are not clearly dated for commencement, the 1815 start date suggested here is probably the very earliest plausible from available information and the early 1820s is more likely, although the nizam example dates from earlier decades.

Dawud also followed the Porte and copied their extermination of the janissaries in 1826.

Georgian Mamluk Baghdad - Army Tablet

Minor Power

Cavalry

Infantry

Artillery





Cavalry  **15**



5	4	3	2	1
---	---	---	---	---

4+

Georgian Guard (0-1)  **16**

 **1**   

5	4	3	2	1
---	---	---	---	---

5+

Artillery  **12**

2	1
---	---

     **5+** **6**



Elite Cavalry  **20**



6	5	4	3	2	1
---	---	---	---	---	---

5+

Levy, Janissary (degenerate)  **6**



 **1**  

5	4	3	2	1
---	---	---	---	---

3+

European Trained Artillery (1815+, 0-1)  **12**

2	1
---	---

   **4+** **6**



Arab or Syrian Cavalry or Dellis  **12**

 **1** ←

5	4	3	2	1
---	---	---	---	---

3+

Janissary (conscript) or Anatolian Reservist  **10**

 **2** 

6	5	4	3	2	1
---	---	---	---	---	---

3+

Sub-Standard Artillery  **5**

2	1
---	---

  **5+** **6**



Kurd Cavalry  **16**

 ←

5	4	3	2	1
---	---	---	---	---

4+

Janissary (guard)  **14**



 **2** 

6	5	4	3	2	1
---	---	---	---	---	---

4+

 Notes, 0-4 Infantry can be Horse Mounted Infantry at +1 point each.

Asgailee Mercenary  **13**

 **2**  

6	5	4	3	2	1
---	---	---	---	---	---

4+



European-trained Infantry (1815+, 0-2)  **13**

 **1**

6	5	4	3	2	1
---	---	---	---	---	---

4+

Albanians  **10**

 **3**  

5	4	3	2	1
---	---	---	---	---

4+

Georgian Mamluk Baghdad - Brigade List

Minor Power

Cavalry Bde

2
0-1 Elite Cavalry
1-3 Cavalry

City Bde

3-5 Levy, Janissary (degenerate)
0-1 Artillery
0-2 Janissary (conscript) ★

Arab or Kurd Bde

2
2-4 Arab *or all* Kurd Cavalry

Infantry Bde

2
3-6 Janissary (conscript) or
Anatolian Reservist
0-1 Artillery or
Sub-Standard Artillery

Syrian Bde

1
2-3 Syrian Cavalry

Guard Bde

1
0-1 Elite Cavalry
0-1 Georgian Guard
0-1 Janissary (guard)
0-2 Asgailee Mercenaries
1-2 Janissary (conscript)
0-1 Artillery (any)

Army Assets

0-2 Janissary (any)
0-2 Asgailee Mercenary
0-1 Albanians

0-1 Artillery (European)
0-2 European Trained Infantry

0-1 Sapeur

0-3 Partizans

Notes: Infantry assets can not be assigned to a Cavalry brigade or an Arab/Kurd/Syrian brigade.

2

Historical Parameters

At War: 1779 - 1822.

Allies: Darfur, Dinka, Shilluk Kingdom, Mamluks, Shayqya Confederacy, Tribal Arabs

Enemies: Darfur / Kordofan 1779+, Civil Wars, Ottoman Turks, Mamluks, Ali of Egypt, Bedouin, Abyssinia, Shayqya Confederacy, Dinka, Shilluk Kingdom.

This list covers the Sultanate of Sinnar in Sudan which in earlier periods it was known as the Funj Empire. The realm had been powerful and expansionist from the 1600s but wars with Abyssinians in the mid 1700s and other neighbours later in the century weakened them. The 1779 start-date is an invasion of Kordofan.

A disastrous period of civil war from 1808 onwards saw the last sultan, Badi VII, surrender the ruined state to Egyptian-Ottoman forces without a fight in 1820. Provincial magnates refused to recognise the surrender and were defeated in battle. The 1822 end date is the last uprising significant against the invader.

The Sultan's guard camels were lancers also with broadswords and shields. Infantry used spears, long straight two-edged swords and shields of elephant or giraffe hide. Swords might be excellent Austrian-made imports. Firearms were rare.

Cavalry used the same arms as the guard camels but added helmets, mail and metallic or fabric caparisons for their horses while reins might be chain rather than leather to avoid enemy cutting them in battle. One clan's 'mail' was leather covered with plates of iron. Some clans were expert swimmers noted as easily crossing the Nile with their horses. The Shayqya tribes are also covered by a separate list but these fought for the Sinnar Sultan - they may have worn less armour and were clad in long shirts of blue or white. Berbers were noted for long braided hair.

Cavalry form the essential brigade as forces were estimated up to 30,000 well-mounted horsemen for some regional governors alone. Egyptian-Ottoman calls for peace were initially rejected because the equestrian ruling classes were by vocation raiders and robbers and left agriculture to others.

Infantry were described by Europeans as hard to kill due to skilled use of shields and some were fighting on having sustained three or four pistol or carbine wounds. They also charged bravely into Egyptian-Ottoman guns taking grim casualties as some men made it to slash at the guns and gunners. They were however defeated by firearms and artillery. Peasant infantry wore a simple coarse cotton kilt with one end thrown over the shoulder. Tribal groups might be adorned with beads, bracelets and trinkets. A southern clan used a 'hand-weapon' bill described like those of former yeomen of England. The description is ambiguous enough for this to be an infantry or cavalry weapon, it is also not clear if the billmen were also armour-wearers. The Shareef of Fezzan had an infantry bodyguard of half-naked blacks armed with spears and halberds for a peer analog.













































The last sultan threw four iron guns (believed of Portuguese make and captured from Abyssinia) into the river rather than let the enemy gain them. At least one small bass cannon was found in an abandoned castle. The 17th century Ottoman accounts of ivory cannonballs from the region are an interesting fantasy. A few hundred refugee Mamluks were in Sinnar in 1820 and more were on the borders. They had bolstered their numbers by training up disciplined black soldiers.

The Egyptian-Ottoman invasion army believed the Sultan would unleash a stampede of cattle herds and elephants* to absorb shooting - if this reflects a previous or possible tactic is unsure as the Sultan opted for peace. It is thus a long stretch 'what-if' troop type and could be represented by riders corralling the herd (the points cost assumes a -2 for the permanent shaken status). Stamping cattle as a military stratagem was historically used by African states to the west of Sinnar. The ethnicity, power and politics of some Nile 'free cities' in the north is far from clear - one similar was a stranded Ottoman garrison of Bosnians.

The last sultan wore green and yellow silks and was shaded by an umbrella in stripes of the same colours - he was accompanied by trumpets.

Sultanate of Sinnar

Minor Power

Cavalry	Infantry	Artillery
Sultan's Guard Cameleers  18  ← 5 4 3 2 1 	Spearmen  9  1    6 5 4 3 2 1 	Iron or Brass Guns  5 2 1   5+ 
Mamluks (0-2)  15  5 4 3 2 1 	Billmen  10  1   6 5 4 3 2 1 	
Cavalry  16 ← 6 5 4 3 2 1 	Levy  6  1   5 4 3 2 1 	
Arab, Berber or Tribal Cavalry or Cameleers  12  1 ← 5 4 3 2 1 	Dinka or Shilluk  9  2   6 5 4 3 2 1 	
Stampeding Cattle and Elephants (0-2)*  8  4 3 2 1 	Nile Free City Defender  6  1   5 4 3 2 1 	

Sultanate of Sinnar - Brigade List

Minor Power

Cavalry Bde  2-4 Cavalry 0-3 Arab, Berber or Tribal Cavalry or Cameleer	Infantry Bde 3-6 Spearmen or Nubians 0-1 Billmen	Army Assets 0-1 Iron or Brass Guns 0-1 Mamluk Remnants 0-2 Stampeding Animals 0-1 Sultan's Guard Cameleers 0-4 <i>Partizans</i> Notes: Army assets can not formed into a brigade they must be included in other brigades.
Arab or Tribal Bde 1 1-3 Arab or Tribal Cavalry or Cameleers 0-2 Levy	Levy Bde 2-4 Levy	
1 0-2 Nile Free City Defender 1-2 Levy Infantry 0-1 Iron or Brass Guns	2	

Shayqya Confederacy

Minor Power

Cavalry

Infantry

Chief's Clan

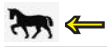

6 5 4 3 2 1



'Nubian' Auxiliaries



5 4 3 2 1



Cavalry



6 5 4 3 2 1



Levy



5 4 3 2 1



Tribal or Arab Cavalry or Camelters



5 4 3 2 1



Note: any cavalry, including the Chief's clan, can delete the Lance Trait for -1 point each.

Historical Parameters

At War: 1780s to 1824.

Allies: Sinnar, Dinka, Shilluk, Darfur.

Enemies: Sinnar, Darfur, Mamluks, Ali of Egypt, Dinka, Shilluk.

Shayqya Confederacy Brigade List

Minor Power

Chief's Clan or Armoured Cavalry Bde

2

1-2 Chief's Guard
1-2 Cavalry (any)

Infantry Bde

2

2-5 Nubian Auxiliaries *or all* Levy

Army Assets

0-6 Partizans

1

Cavalry Bde

2-5 Cavalry (any) 
0-1 Tribal or Arab Cavalry or Cameleers

The Shayqya Confederacy here represents the 12 tribes acting independently of the Sultan of Sinnar, especially as that state declined. They would otherwise be included within and part of the state and can indeed form an allied contingent for Sinnar.

Infantry during their conflict with Ottoman-Egyptians in the 1820s was initially provided by 'Nubian auxiliaries' which could mean free tribal, allies, subjects or mercenaries from a range of clans including the Dinka and Shilluk. After an initial defeat the infantry at a second battle with the Ottoman-Egyptians was described as a levy of conscripted peasants - these were rendered bullet-proof by a holy man administering spells and sprinkling magic dust onto the men.

The army can include the warrior-poetess and chief's daughter Mihera Bint Abboud riding a decorated camel and waving a sword, in imitation of a famous historical figure, to inspire the men. This sounds like a compulsory Huzzah! marker.

Cavalry should look broadly the same as those from Sinnar and related groups with a note that only a few leaders had pistols. The Lance Trait is optional to reflect those men with javelins but lacking a longer spear.

The army can optionally be of **Feudal Doctrine**.

Historical Parameters

At War: 1780s to 1826.
Allies: Sinnar, Darfur, Dinka, Nuer.
Enemies: Sinnar, Darfur, Dinka, Anuak, Nuer, Nuba, Egyptian-Ottoman, Baggara Tribal Arabs.

This list covers the Nilotic peoples of South Sudan and related tribes, they are included to provide allies and enemies for their northern neighbours.

The Shillouk 'king' / 'Reth', was probably initially the leader of a tribal alliance that strengthened during a period of expansion north during the 17th century. The state's capital was the city of Fashoda / Pachod.

The 1826 end date represents significant Egyptian-Ottoman slave-raiding incursions into Shilluk heartlands, albeit the conflict started with invasion in 1821. The Shilluk also suffered from Dinka attacks in the 1820s. The start date is an estimate for the reign of King Nyakwaa c.1780-1820.

The Shilluk were allied with Darfur and possibly other peoples normally within the Funj hegemony. The Shilluk were noted for their large fleets of dug-out canoes which might be crewed by up to a dozen men sitting in a single line down the craft. Canoe fleets gave the Shilluk a significant fast raiding capacity and naval supremacy until Egyptian-Ottoman sail boats appeared. The ADC for them represents strategic initiative provided by their fleets and not excellent divisional staff structures. Dinka and Shilluk warriors were infantry armed primarily with broad-bladed spear and long oval or leaf-shaped shield. Other weapons included knives, clubs and probably throwing-irons and throw-sticks for some clans. Firearms appear in any numbers only after the 1820s and into the 1850s were still described as rare and poor-quality weapons. Clubs might be thrown.

Bath Reth translates as king's men / king's fighters and represents his personal suite of officials, body-guard, private army, police force, hangers-on and similar.

Dinka and Nuer were semi-nomadic pastoralists with a less centralised ruling authority and a more dispersed population than the Shilluk but still with a military capacity. The youths listed for these people assume that like other Nilotic pastoralists to the south they organised warriors into age-set groups.

Warriors wore bracelets, necklaces, armbands, exotic hair styles and feathers. The Nuer's plaited hair might be covered in potter's clay to resemble a helmet if viewed from a distance. One Shilluk prince wore a blue shirt where his men wore loin cloths.

Infantry		Infantry		Infantry	
Bath Reth (0-2) 12 6 5 4 3 2 1		Warriors 10 6 5 4 3 2 1		Youths 6 5 4 3 2 1	
Youth Bde (For Dinka, Nuer) 2 2-4 Youths		Warrior Bde 3-6 Warriors		Army Assets 0-2 Bath Reth if Shilluk 0-1 ADC if Shilluk 0-6 Partizans 2	

Historical Parameters**At War:** 1770+**Allies:** Tribal Arabs, Shilluk Kingdom, Sinnar.**Enemies:** Sinnar, civil war, Bornu, Wadai, Tribal Arabs, Fezzan-Tripoli.

This list covers Darfur in the Sudan, also known as the Keira Sultanate. The Sultan became known in the west, among other things, for his writing to congratulate Napoleon on defeating the Mamluks and Napoleon's reply requesting 2000 black slaves to be trained as soldiers. It is not known if they were subsequently supplied.

Darfur was often in conflict with Sinnar as each could block major trade routes. War raged over control of the Kordofan area. An independent if small Kordofan *Musabba'at* dynasty, 1772-92, and the smaller state of Wadai to the west can be represented by this list. Conflict also occurred in Darfur's west with the Bornu and the Fezzan-Tripolitan states.

A significant proportion of the military was provided by Arabs or Berbers. Reports of the size of armies varied greatly. A Mamluk refugee from Ottoman-Egyptian expansion said in 1820 that Darfur '... could muster 100,000 men armed, in the field, equipped with artillery and mortars (they were given 8 guns and mortars from Egypt)... they had made others, and worked them as well as the people of Egypt ...'. However a force to oppose the Ottoman Egyptian invasion was 8000 infantry, 200 armoured cavalry and 1000 other cavalry. The defenders were caught unprepared and other troops from the south and west could not coordinate.

In 1796 Achmet Agha / Giovanni Gaeta a Greek turned Moslem formerly employed by the Mamluks as an artillery manufacturer went to Darfur with a team of 50 or 60 artificers and four brass 6-pounders. Some accounts say he was also a spy for a possible Mamluk invasion. In any case the idea was orchestrated by the Venetian consul in Cairo. Achmet appears to have been executed in 1798 for supporting a coup against the Sultan. Guns included an antique piece maintained since the 1680s and others such as four iron guns at the capital associated with the odd European freebooter helping to train forces from about the same time.

Musketeers were not common, they used a variety of weapon types, sometimes firing copper or iron bullets. In a succession crisis in 1787 both contending sons employed foreigners using firearms - one side sensibly used spells and sorcery to cause the other to miss their shots and their own to always hit.

The area was famous for padded or metallic armour, even into the 1870s, which may not be limited to cavalry. Weapons were spears, swords and arm-daggers. Many arm-daggers were also a throwing knife. These were believed to be aimed at the legs of men and horses and may explain the popularity padded armour. Hunting boomerang-like or T-shaped sharpened throw-sticks were a weapon for tribes in the west of Darfur but also used elsewhere including by other nations to the west and south. Knives of various sickle-shapes with projecting blades and handle could be the item described as a 'hatchet' as used against the Turks.

Some women were fighters for Kordofan. The Musabba'at sultan Hashim was determined to found a strong state in Kordofan and once employed a diverse group of 10,000 mercenary soldiers. His final attempt to regain his lands saw him defeated by Darfur in 1801.

Costume included a rich tribe in long white shirts and white caps. Others were nearly naked warriors in sandals with arm-dagger, long straight sword, large oval antelope skin shields and a number of javelins in a crude leather quiver on their shoulder. A clan of Nuba slave soldiers lived in east Darfur.

The sheik / king's camp guard carried 3-6 light javelins and a shield, they also had drums to sound the alarm. In parade the ruler was led by two royal throwing-knife bearers. The carrying of three knives in a leather shoulder-bag appears to be a modern or Bornu feature. Some tribes had superb camels but also rode horses. Tribes could be Arab, Berber or others. A minority of infantry had bows and the option is given to group them but they could also be part of other units. Riders might wear mail and helmet in stead of or in addition to cloth padding while others were unarmoured with spears.

Sultanate of Darfur

Minor Power

Cavalry

Infantry

Artillery

Armoured Cavalry 18

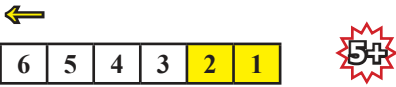

Arab or other Cavalry 16

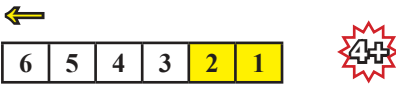

Tribal Cavalry or Camel riders 12



Egyptian or North - African Musketeer (0-2) 11

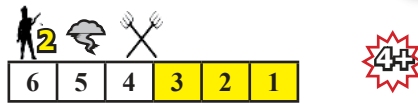

Bowmen 5

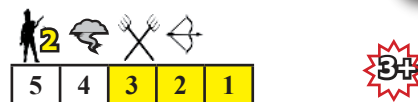

Spearmen 9



Guards, Swordsmen or Hatchet-men 12

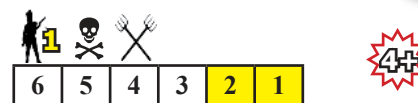

Iron or Brass Guns 5



Sultanate of Darfur - Brigade List

Minor Power

Royal Bde

- 1**
- 1-2 Armoured Cavalry
 - 1-3 Cavalry (any non-armoured)
 - 0-2 Guards
 - 0-1 Iron or Brass guns

Cavalry Bde

- 2**
- 0-1 Armoured Cavalry
 - 1-3 Cavalry (any non-armoured)

Army Assets

- 0-1 Iron Guns
- 0-2 Musketeers
- 0-6 Partizans

Infantry Bde

- 2-5 Spearmen 
- 0-1 Bowmen
- 0-1 Swordsmen or Hatchet-men

Tribal Bde

- 1-3 Tribal Cavalry or Camel Rider
- 0-2 Spearmen

1

Historical Parameters

At War: 1788 - 1822.

Allies: Ottoman Turks, French 1797+, Russia 1798-99, British 1809*+.

Enemies: Ottoman Turks, French 1798+, Venetian Republic, Septinsular Republic - Russia 1807, Austria 1787-1791, Balkan minor states and rebels.

This list covers Ali Pasha *'The Lion of Ioannina'* of Albania. Ali gained fame in the 19th century as an exotic oriental despot who was either autonomous, or semi-independent of the Ottomans. He was a crafty intriguer whose military adventures were calculated to advance his own interests as much as those of the Porte. Perceptive readers will wonder why Albanians are in a volume of 'non-European' armies; which is a good question.

At times Ali's forces were summoned to be part of the Ottoman war with Russia in the Danube campaigns and at other times he had independence and diplomatic relations with European powers. Following the French defeat of Venice and subsequent occupation of her Dalmatian and Ionian Sea Islands, the area became a contest of French, British, Russian, Albanian and Turk interests.

Ali rose from a bandit leader to be appointed pasha in 1787-88. He eventually controlled much of modern Albania, significant parts of Greece and neighbouring Balkan states. Recorded actions were mostly minor battles or assaults on cities and forts - Ali's neighbours were generally either too small to oppose him in the field or too large to be provoked. In addition to his three horse-tail banner Ali's flag depicted a zulfiqar - the double-blade sword popular in Islamic states.

The Venetian Republic enemy is slight a 'what if', no significant actions were fought as Ottoman treaties curbed Ali's desire to capture port cities. French, Russian and British* allies are also 'what if' as each offered more weapons, advisors and troops than they ultimately provided: note also the troops in the Army Tablet. Both Napoleon and the British dangled the suggestion of Ali becoming king of an independent state. Ali was negotiating with Napoleon in the 1790s and Consul Lasalle (not our man, another one) offered military aid in 1792. After the fall of Venice (1797), Istanbul sent forces for Ali's use near the Adriatic coast and islands. Napoleon's invasion of Egypt forced Turkey and therefore Ali into war and he captured French Preveza in 1798.

In 1798-99 Ali sent forces to join the Ottomans and Russians opposing the French at Corfu. From 1807 the French, now friends, sent artillery and gunners (and a company of Neapolitans) to train locals and establish military academies. Frenchmen captured by pirates also became military advisors in the 1790s later joined by freelance English, German and Frenchmen. In 1808-09 the British supported Ali to upset Russian-Turk friendship and sent him 500-600 Congreve rockets, and modern artillery, with instructors to train local operators. Howitzers and a battering train were noted in assaulting enemy cities and forts - the rockets were used successfully in at least two such actions.











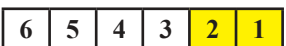

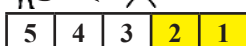

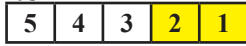

Souliots are Christians noted for their fierce resistance to the Turks. They were usually Ali's enemies but some clans sided with him and in 1820 they provided 3000 troops as allies. Some women were fighters. Klephts 'bandits, thieves' were Greek mountaineer or outlaw clans. Armatoloi were the organised Christian Greek (or occasionally Albanian) feudal militia also tasked with combating the Klephts. The difference between the outlaw and police was often not clear.

Ali's forces included mercenaries, at least 3000 cavalry (including some black slaves) and janissaries who could be locals or from Constantinople. Estimates of his military range from 40,000, 50,000, 80,000 men with armies of 10,000-20,000 sent to assist the Porte or for other actions. A core of 7000-8000 soldiers (in 1807) appear to be permanently embodied and treated here the same as janissaries upon which they may have been modelled and indeed are sometimes so called. Ali also looked for inspiration from European methods. Classifying the clans and irregulars is difficult given a lack of detailed description of them in larger actions. Most were armed with musket, pistols, sabre and dagger.

Ali's luck ran out in 1820-22 as the Porte's armies defeated him. Refusing to surrender he died fighting in a monastery. His head was sent to Constantinople. Ali's extended independence from Istanbul helped inspire Greek liberation.

Ali Pasha of Albania - Army Tablet

Minor Power

Cavalry	Infantry	Artillery
Albanian or other Balkan Cavalry  15  4+	Armatoli, Souliots Albanian Clans  10  4+	Traditional Artillery (0-2)  12  6
Greek Sipahis  12  3+	Klepts or Mercenaries  8  3+	French, or British Supplied Guns (0-1)  10  6
	Janissary (conscript) or Albanian Regulars  10  3+	British Supplied Rockets (0-1) 1809+  5  6
	Janissary (veteran)  12  4+	



Ali Pasha, the Lion of Ioannina

Ali Pasha of Albania - Brigade List

Minor Power

Regular Infantry Bde

2

- 2-4 Albanian Regulars or Janissary (conscript)
- 0-2 Albanian Clan
- 0-1 Traditional Artillery

Cavalry Bde

2

- 2-3 Cavalry or Sipahi

Klept or Mercenary Bde

2

- 1-3 Klephts or Mercenaries

Souliot or Armatoli Bde

2

- 2-5 Souliot or Armatoli

Albanian Clan Bde

- 2-5 Albanian Clan



Army Assets

- 0-2 Janissary (any)
- 0-1 British Rockets
- 0-1 French or British - supplied Artillery
- 0-1 Traditional Artillery

0-6 Partizans

Note - Army assets may not be formed into a separate Brigade. No Assets can be given to a Klepht, Mercenary, Souliot or Armatoli Bde.

2



Left and Center, Albanians. Right, a Janissary from Ioannina. Below, a Souliot.



Historical Parameters

At War: 1795+

Allies: Ottomans, Algeria, Tunisia, French in Egypt, Shareef of Fezzan.

Enemies: Ottomans, French, Tunisia, any European naval states, USA*, Tuareg, Bornu.

This list covers the Karamanli Dynasty in Tripoli as an autonomous regency within the Ottoman sphere. Unlike the other Barbary states of North Africa the Karamanlis established a hereditary dynasty starting with Ahmed Karamanli r. 1711-45 who was officially recognised by the Turks in 1722. The threat of Ottoman re-assertion of control was a constant and from time-to-time the Porte might back a coup attempt by a disgruntled claimant. Independence was ended in 1835. The 1795 start date for the list is the restoration of Ali Karamanli, with Tunisian help, following the temporary dictatorship of an Ottoman-backed pirate regime.

Tripoli was famous in the west as the base for pirates with a taste for enslaving Europeans. A significant portion of the national income came from such raiders as well as trading slaves from central Africa. Merchant ships from European states with powerful navies would either be left alone or charged protection money. Smaller European states would be kept as potential victims. The US republic decided in 1801, after five years, to stop paying (increasingly inflated) protection money leading to famous American military interventions in North Africa until 1815.

Land forces included; janissaries, mixed race Turk-Arab *Kuloghi* rural cavalry, Berber and Arab tribes, city mobs, Black and other *Hampas* palace guardsmen, European renegade advisors and various mercenaries or slaves. In 1712 the 'standing' army appeared to be 5000 janissaries and 3500 mounted Kuloghis. In about 1812 the state, then in good financial times, could field 30,000 infantry, 15,000 Kuloghi cavalry and 30 mobile guns.

The Pasha of Tripoli was entitled to carry a three horse-tail standard which marked a senior position within Ottoman hierarchy. The state's flag was red and yellow horizontal stripes of various numbers while other flags were noted as red and white stripes or green with or without crescents.

Pirates were armed with musket, scimitar and dagger. Janissaries were much the same as Turk or Egyptian varieties albeit noted for their modest quality, Berber and Arab riders used lance and a fire-arm as perhaps did the Kuloghis.

The US intervention in 1805 to oust Pasha Yusef and install his brother Ahmed / Hamet Bey was to force negotiations for safe merchant shipping and the release of prisoners. US marine officer Lt. Eaton retrieved Hamet from exile in Egypt where he was fighting with a Mamluk faction. A mercenary force of Greeks (mostly gunners with one piece) other Christians, sundry camel-riders, a few Mamluks, Arabs and a variety of European freebooter officers (in a variety of uniforms) and a handful of US marines captured the city of Derna with the help of the US navy bombardment and deserting town defenders. Derna was unsuccessfully defended by Mustafa Bey who met a call to surrender with the reply: 'your head or mine'. The force can be depicted as a motley collection of soldiers on the infantry and artillery bases. Including such units* assumes the 'what if' of an expanded civil war with soldiers joining both sides. The US-Hamet force intended to take Tripoli and Yusuf had already gathered an army in opposition. The small US Brigade represents the forces available after the fall of Derna as opposed to the 400-700 who marched there. The Artillery can include the original Greek-crewed gun(s), those detached from the navy and the captured 9-pounder battery at Derna. The US troops carried a flag of 15 stars and stripes. The conflict was ended by negotiation and Hamet returned to exile.

Including the Central African state of Bornu as an enemy is drifting into 'what if' territory as there were mostly border skirmishes with the Shareef of Fezzan. The hereditary Shareef of Fezzan, in the interior south of Tripoli, was a vassal loosely tied to Tripoli. At times he was also at war with Tuareg tribes. Turkish guns and soldiers were exported in small numbers to Bornu and points west via Tripoli from the late 16th century.

Civilian mobs, levies or tribes can include Bedu and Berbers with long guns and knives and 'Moors' with pistols and sabres. An army can include *Marabouts* - mystic or mad religious persons (thus analogous to dervishes elsewhere in the Islamic world) in odd clothing encouraging troops by quoting holy texts or uttering spells and curses at the enemy.

Tripoli - Army Tablet

Minor Power

Cavalry

Infantry

Artillery

Kuloghi Cavalry



15

6 5 4 3 2 1

4+

City Defenders or Tribal Infantry



6



5 4 3 2 1

3+

City Artillery



12

2 1



5+

6

Berber or Arab Tribal Cavalry



12



5 4 3 2 1

3+

City Rioters or Levy



6



5 4 3 2 1

3+

US Artillery (0-1)



10

2 1



4+

6

Corsairs



9



5 4 3 2 1

4+

Janissaries (veteran)



12



6 5 4 3 2 1

4+

Janissaries (conscript)



10



6 5 4 3 2 1

3+

Black / Hampas Palace Guard



9



5 4 3 2 1

4+

US Marines, Greek and other Mercenaries (0-1)



16



6 5 4 3 2 1

4+

'What ifs'

In 1789 Napoleon negotiated a treaty with the Pasha of Tripoli to permit the landing of French troops and supplies as a base to then be transported to Cairo. It appears French offers included the prospect of recognising Tripoli as fully independent from the Ottomans and a formal alliance.

So a 'what if' could be French troops co-operating with the Pasha - a prospect that looked plausible to Tripoli following the early French victories in Egypt.

Notes: Tribal infantry can be 'half-naked and half starved' back county supporters of the Pasha who in groups of up to 1000 were armed with matchlocks. Each tribe might have a Marabout carrying a small green flag.

The Pasha's personal guard of 40 men were sometimes called Mamluks. When dismounted were armed with a blunderbuss like the other foot guards.

The Shareef of Fezzan's forces included the Toubou / Tibu 'black nomads' of Chad - they were armed with a 2m spear and a long knife strapped to the left arm. Count these as Tribal or Levy troops.

Tripoli - Brigade List

Minor Power

Infantry Bde

2-5 Janisaries (conscript)
 0-1 Janisaries (veteran)
 0-2 City Defenders or Levy
 0-1 City Artillery

City Bde

2 1-3 City Defenders
 0-4 Rioters or Levy
 0-1 City Artillery

Army Assets

0-2 Black / Hampas Guard
 0-1 City Artillery
 0-2 Corsairs

0-3 Partizans

Note - Army assets may not be formed into a separate Brigade. Infantry Assets can be attached only to an Infantry or City Brigade.

Cavalry Bde

3-6 Kuloghi Cavalry
 0-2 Arab or Berber Cavalry



Berber or Tribal Arab Bde

2 1-3 Berber or Arab Tribal Cavalry
 0-2 Tribal Infantry

American Bde (1805)

1 1 US Marines, Greeks etc
 0-1 US Artillery
 1 Kuloghi or Arab cavalry
 0-2 City Defender

2



Some images of Tripolitanians accompanying Miss Tully's diary documenting her stay 1783-93.



Historical Parameters

At War: 1770s - 1824

Allies: Kazakh Horde, Kirghiz or similar clan.

Enemies: Burma 1771-76+, Vietnam 1788-89, Korea, Kokhand 1750s+, Khoja insurgents, Tibet 1787-88, Nepal-Gurkhas 1790-92, Britain 1808/16*, White Lotus Rebels 1794-1808, Nanlong Uprising 1797, Miao Rebellion 1795-1806, Eight Trigram Rebels 1812-14, Formosa 1788-89.

This list covers the Chinese Qing / Ch'ing Dynasty. The end is the first British war with Burma - to represent a significant European intervention in the Chinese sphere of influence. Britain* is listed as a 'what-if' enemy in 1808 by assuming brinkmanship over Britain's occupation of Macao (justified to stop the French doing the same) could have easily escalated into serious conflict, in effect bringing the Opium Wars earlier by three decades or so. The British left the island after the Emperor threatened to send an 80,000-strong army to expel them. In 1816 the Qing massed an army in Tibet to shadow the British invasion of Nepal, offering another potential flash point.

Chinese armies of this period are often viewed through the prism of calamitous defeats in the mid to late 1800s at the hands of technologically advanced western armies. The military does show signs of complacency and neglect from the late 1700s, either due to diffusion of Manchu vigour or because they had subdued their larger neighbours and thus faced no serious threats. Leadership was conservative, corrupt and bureaucratic, however even armies apparently destroyed by westerners might reform a week or two later and individual soldiers showed bravery and dash when required. The defeat of Imperial forces by White Lotus and Nanlong rebels exposed embarrassing inefficiencies. The related Eight Trigram rebels almost staged a coup as they got an armed mob into the Forbidden City, several provinces and cities declared for them and were subsequently captured by government forces.

The army was founded on the eight banner system, reflecting the colour of the triangular 'divisional' flags being; yellow, red, white and blue for the first four and the same colours edged with red for the next (the second red banner was edged white). These were supplemented by imperial divisions, reservists, militia and the Green Standard formations. Two yellow and a white Banner had a senior status under a Manchu khan.

Ethnic division into Manchu, Mongol and Han/Chinese could be reflected in some units. The massive military could number at least half a million strong but many of the banner units had degenerated to the point of not deserving to be classed as soldiers. Hereditary recruiting into regular units corroded discipline and effectiveness.

Banners could have two to five 'regiments' nominally of five 300 man 'companies' but the number was often in the 100-150 man range for companies. Details for all organisational structure varied widely. Units were mostly infantry but could include cavalry.

The imperial divisions included six formations to protect the Emperor and the Forbidden City, the men were often promoted from the banner units. The formations were:

Imperial Bodyguard of 3000 cavalry armed with swords, halberds and at least some with bows.

Vanguard Division of 1500-2000 cavalry armed with matchlocks, sword, bows.

Flank Division of 14-16k men, possibly in eight units, as a mix of cavalry and infantry these were armoured, these used bows, matchlocks, swords and half were armed with 10-foot spears,

Light Division of 3000-4000 comprised of foreigners or savages, these were armoured had helmets and used matchlocks, bows, halberds and sword. They wore yellow jackets,

Fire-Arm Division of 8000, wearing helmets and thick leather armour, in two formation one of matchlocks the other jingals wearing blue jackets.

The final formation was the **Paid Force** of 36,000-42,000 cavalry of which 1/8th was Mongol and the rest evenly Manchu and Chinese. Within or additional to these were 7000 matchlock men including a body of 1000 picked from the banners, 100 sword and buckler men (tigers?) and 100 Artillerymen.

Other foot forces at the capital outside of these divisions were up to 30,000 strong and included a body of matchlock cavalry and a *Yuan Min Yuan* division of 5000-6000 in red jackets.

Finally the Emperor could call on the **Tiger Guards** being the famous costumed tiger-men being 4000 at Beijing but these were also parcelled out or replicated in other units.

Green Standard units, of ethnic Han Chinese, were noted as initially of better quality than the eight-banner troops but over time they fell to the same corruption and neglect while many were police rather than soldiers. The Green Standards could muster up to 18 'armies' being anything from 5000 to 50,000 strong in three broad categories; garrison troops, mobile troops and cavalry. 'Battalions' varied in size but 525 infantry and 250 cavalry were noted.

Reservists / militia were organised into companies of 100 men supplied with pikes, halberds or bows by the state. Better urban militia might be given uniforms and pay.

Masses of militia were raised to fight the White Lotus rebels with up to a third of a million men serving at some stage. The Banner armies were considered better deployed against foreign threats and the militia a cheaper option to fight rebels. Both ideas proved false. Green Standard and Banner units were needed to help defeat the rebels and the massive enrolment into the militia provided expanded avenues for pay corruption and creeping demands for food, weapon and relocation expenses - which might be syphoned off to fund lavish banquets for the generals.

Militia could be used as a first wave in front of regular troops to soak up casualties (Banner troops were happy to let Green Standard units do the same for them). Presumably this toughened many up and some militia formations became known as effective fighters with the men serving for several years.

'Mercenaries' could be hired, their training or quality is uncertain but could number up to 10,000.

Cavalry was typically deployed on the wings of an army where they skirmished and swarmed - they could be supported by jingal teams who transported their weapons on pack horses.

Infantry units could form up ten or five ranks deep with a multitude of flags at the front. Runners in front of units had semaphore-like flags to relay orders, these men would lie down as their units shot above them. Units with mixed weapons would form up by files of the same weapon, pike, matchlock, spear, sword and so on. Infantry units were supported by a cloud of skirmishers in front being two-man jingals and sword-and-buckler men. Shooting was by counter-march rank rotation. Only the worst infantry deserve Rabble classification as most were trained in anti-cavalry techniques including forming squares. Massed Tigermen units are also assumed not to be a solid formation.

Mixed spear/halberd and matchlock infantry gain the Part-Pike Trait. Troops' Sk value is kept modest without speculating how in might compare with Europeans. Units later in the 19th century might break into all skirmishers.

Bows were not a common infantry weapon and the repeating crossbow even rarer. The woodwork of matchlocks could be painted bright red or yellow. Some infantry spears were 20 foot-long bamboo but 12-15 foot was more likely. Tigermen were armed with fire-crackers, sword and shield, they were specialist skirmishers and expected to scare horses by fireworks, acrobatics and flashing their decorated shields.

Artillery would deploy strung out in front of an army or to the wings. Jingals could be a two-man type as part of infantry formations or three-to-five man larger weapons on stands, companies of 20 jingals are mentioned. The larger types might be loaded on horses for transport and some could be charged with up to 20 bullets for their 'canister' effect.

Guns could be of a vast variety of types and many of the larger ones had only a small bore. Rockets were a traditional weapon and could be fire singly or from basket-launchers. Bodyguard units might have two attached light guns for Regimental Guns status as per the Advanced rules.

Cavalry retained bows as a weapon but in declining numbers thought the 19th century, used perhaps in addition to fire-arms - presumably as an aristocratic or status weapon similar to conservative Islamic Turco-Mongol contemporaries. Cavalry spears and polearms were 6-7 feet in length and sometimes painted red.

Qing Army Tablet

Major Power

Cavalry



Infantry

Artillery

Imperial Bodyguard or Vanguard Cavalry  15

6 5 4 3 2 1 

Flank Division  12

 1  P 
6 5 4 3 2 1

Artillery  8

2 1  5+ 

Flank Division, Paid Force, Eight Banner or Green Standard Cavalry  12

5 4 3 2 1 

Light Division  13

 2  P 
6 5 4 3 2 1

Heavy Artillery  10

2 1  5+  

Second-rate Cavalry  10

5 4 3 2 1 

Firearms Division  12

 2  
6 5 4 3 2 1

Rocketeers, Rocket-launchers  5



2 1   5+  

Earthworks

A Qing army may purchase up to two x 4BW-long section of Earthworks, for four (4) points each.

They must be placed during set-up within 1BW of an Artillery unit of any type.



Eight Banner, Green Standard or similar  10

 1  P 
6 5 4 3 2 1

Light Guns  5

2 1  5+ 

Senior Banner Infantry  12

 1  P 
6 5 4 3 2 1





Jingal  6

2 1  5+ J 





Garrison or Second Rate Infantry  8

 1  P 
5 4 3 2 1



Militia, Mercenaries or Rural Reservists  6

 1   
5 4 3 2 1

Tiger Guard  12

 3   
6 5 4 3 2 1

Uniformed Urban Reservists  7

 1  
5 4 3 2 1



A tiggerman as seen by the 1792 British delegation.

Qing Brigade List - Line Corps

Major Power

Cavalry Bde

2

1-3 Flank Division, Paid Force, Eight Banner or Green Standard Cavalry
0-2 Second Rate Cavalry
0-1 Jingal

Banner Infantry Bde

2-5 Eight Banner, Green Standard or Similar Infantry
0-1 Senior Banner Infantry
0-2 Garrison or Second Rate Infantry
0-4 Militia or Reservist (any)
0-1 Jingal or Artillery or Light Guns

Line Army Assets

0-1 Heavy Artillery
0-2 Light Guns
0-2 Artillery
0-2 Jingals
0-2 Rockets

0-3 Partizans
0-2 Sapeurs (guanji)

Army Assets can not be formed into a Brigade of their own.

1

Imperial Bde

1

Choose one of the Elite Corps Brigades from below

Second Rate Infantry Bde

2-6 Garrison or Second Rate Infantry
0-2 Militia or Reservist (any)
0-1 Jingal or Artillery or Light Guns

Militia or Mercenary Infantry Bde

2-6 Militia, Mercenary or Reservist (any)
0-1 Light Guns

Qing Brigade List - Elite Corps

Major Power

Bodyguard Cavalry Bde

1

2-3 Imperial Body Guard Cavalry
0-1 Cavalry (any) 
0-1 Jingal

Flank Division Bde

2-4 Flank Division
0-1 Jingal or Artillery or Light Guns 

Line Army Assets

0-2 Heavy Artillery
0-2 Light Guns
0-2 Artillery
0-2 Jingals
0-2 Rockets
0-1 Tiger Guards

0-1 Sapeurs

Army Assets can not be formed into a Brigade of their own.

1

Cavalry Bde

2-4 Cavalry (any)
0-1 Jingal

Light Division Bde

1 2-4 Light Division
0-1 Jingal or Artillery or Light Guns

Note: An Elite Corps must take at least one of the Essential Brigades as marked.

Fire Arm Division Bde

2 1-3 Firearm Division
1-3 Jingals

Tiger Guards Bde

1 2-3 Tiger Guards

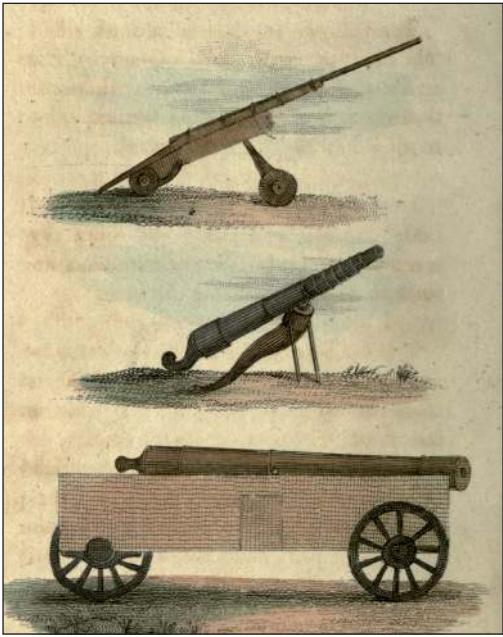

Pictures from European visits in the 1790s. *Above Left*, 'Chinese Artillery', *Above Centre*, an officer who had campaigned in Tibet, *Above Left*, 'Tartar Musqueteer'.



Above Centre, an 'Officer of Bowman', one man in every 5 to 9 had a back banner. *Above Right*, soldier and standard as part of an Emperor's parade. Except for the artillery and Tartar the pictures are by William Alexander.

